



1	550	379	1	2/2
2	516	375	1	2/2
3	365	377	1	2/2
4	349,5	373	1	2/2
5	335	371	1	2/2
6	166	371	1	2/2
7	330	180	1	2/2
8	302	140	1	2/2
8L,8R	302	140	2	2/2
9	313	300	1	2/2
10	378	363	1	2/2
11	545	373	1	1/2

NR 1

B1  8x28 x10

B20  8x50 x2

M1  15x12mm x16

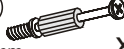
T1  5x39mm x10

T18  L=64 x2

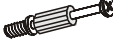
T7  M6x35 x2

NR 2

C14  mm x8

S6  3x20 x13

S26  4x25 x8

G7  S4 x1

NR 3

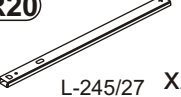
R20  L-245/27 x2

E24  6,0x11 x4

A01  M4x9 x2

T2  5x32mm x2

M2  12x10mm x2

P5  4x30 x4

NR 4

U107  x1

A14  M4x22 x2

NR 5

J11  x1

P13  3,5x13 x2

T13  8x50 mm x1

T14  6x50 mm x1

C 2/2



G25  M6x25

10 20 30 40 50 60 70

G25  M6x25 x4

C 1/2

1

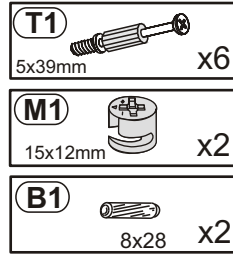
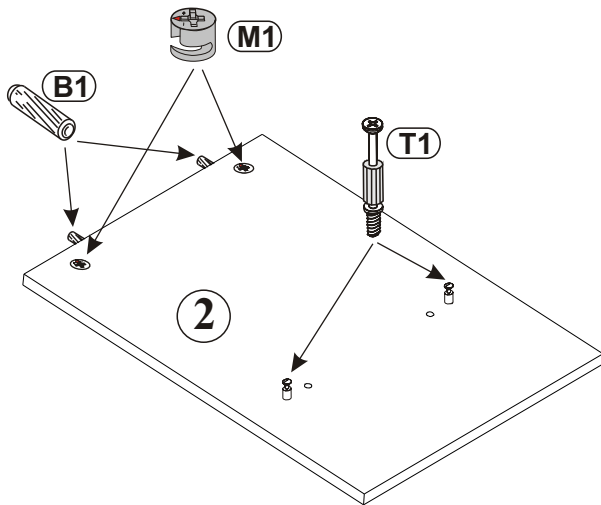
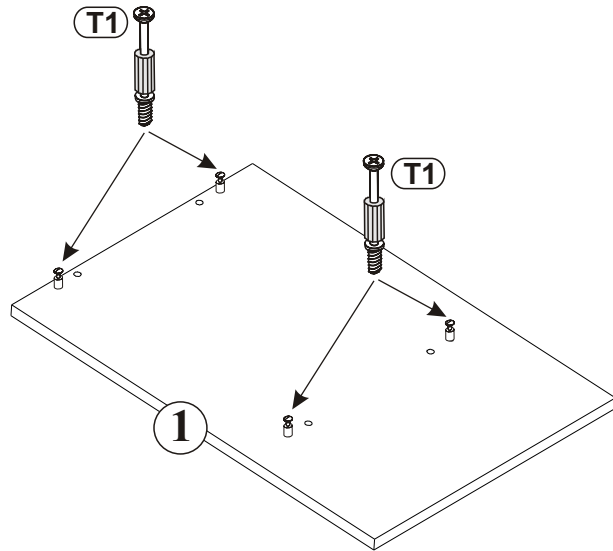

2

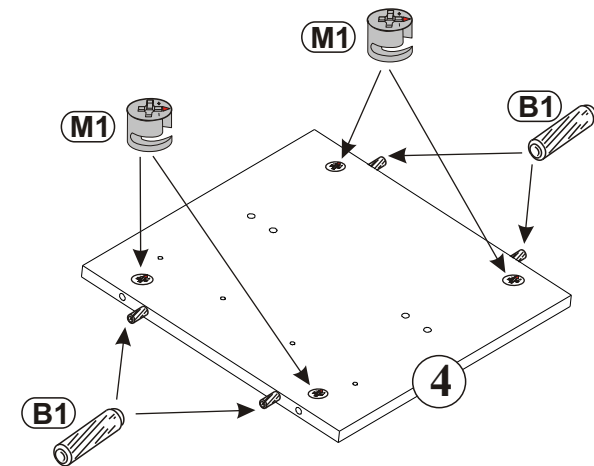
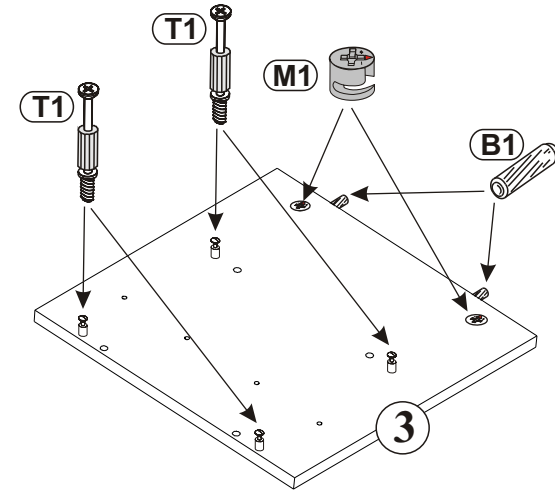
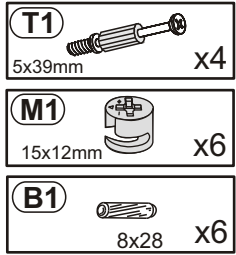
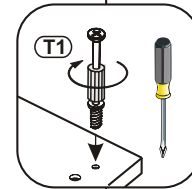
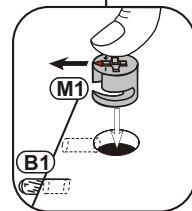
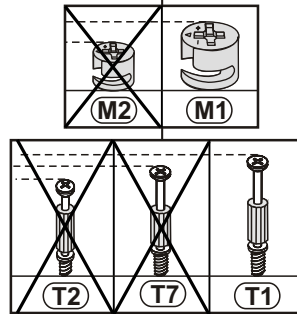

3

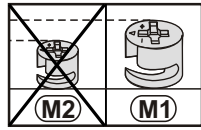

- M1** 15x12mm x8
- B1** 8x28 x2
- B20** 8x50 x2
- T18** L=64 x2

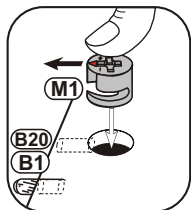
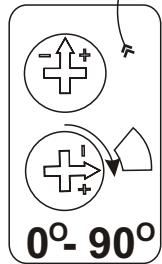

4

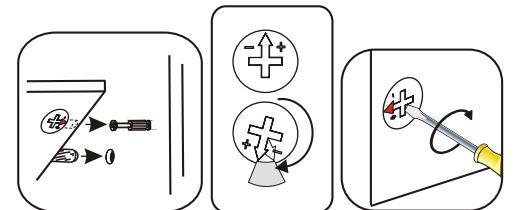
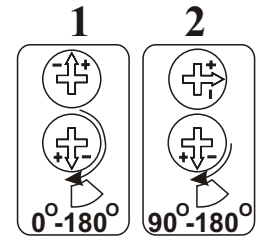
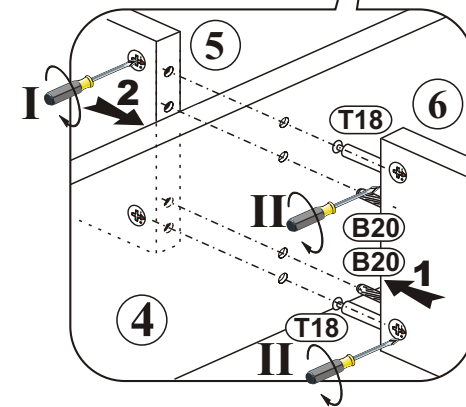
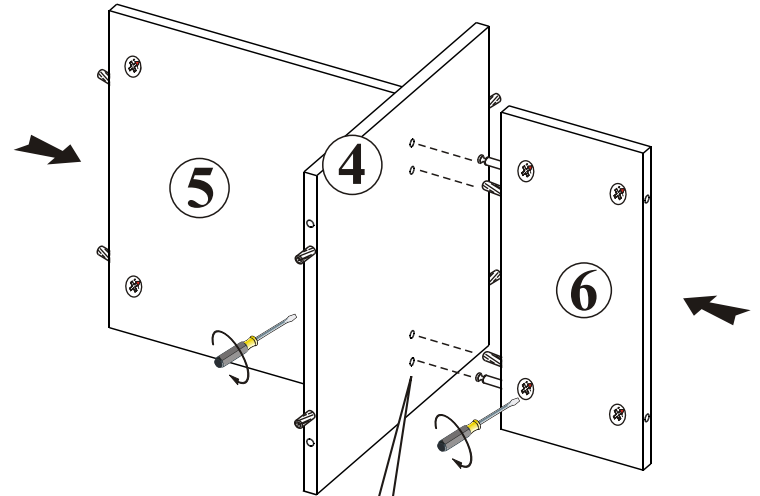

5

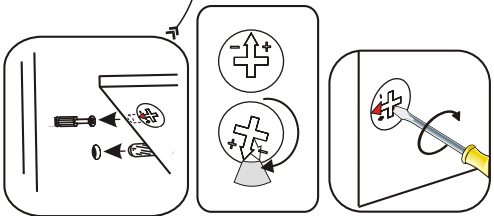
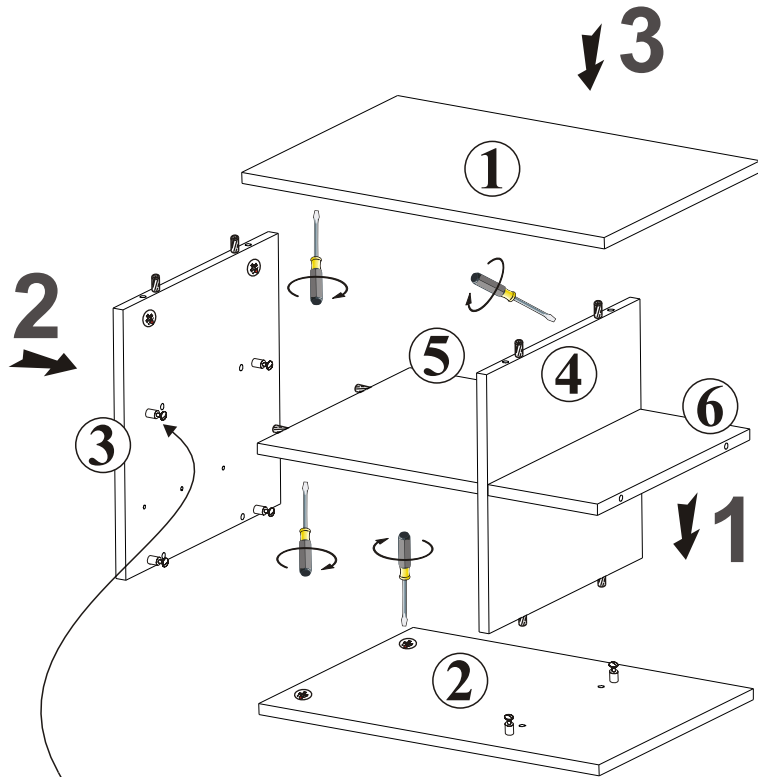

6

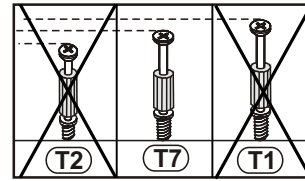

- G25** M6x25 x4
- G7** S4 x1
- T7** M6x35 x2

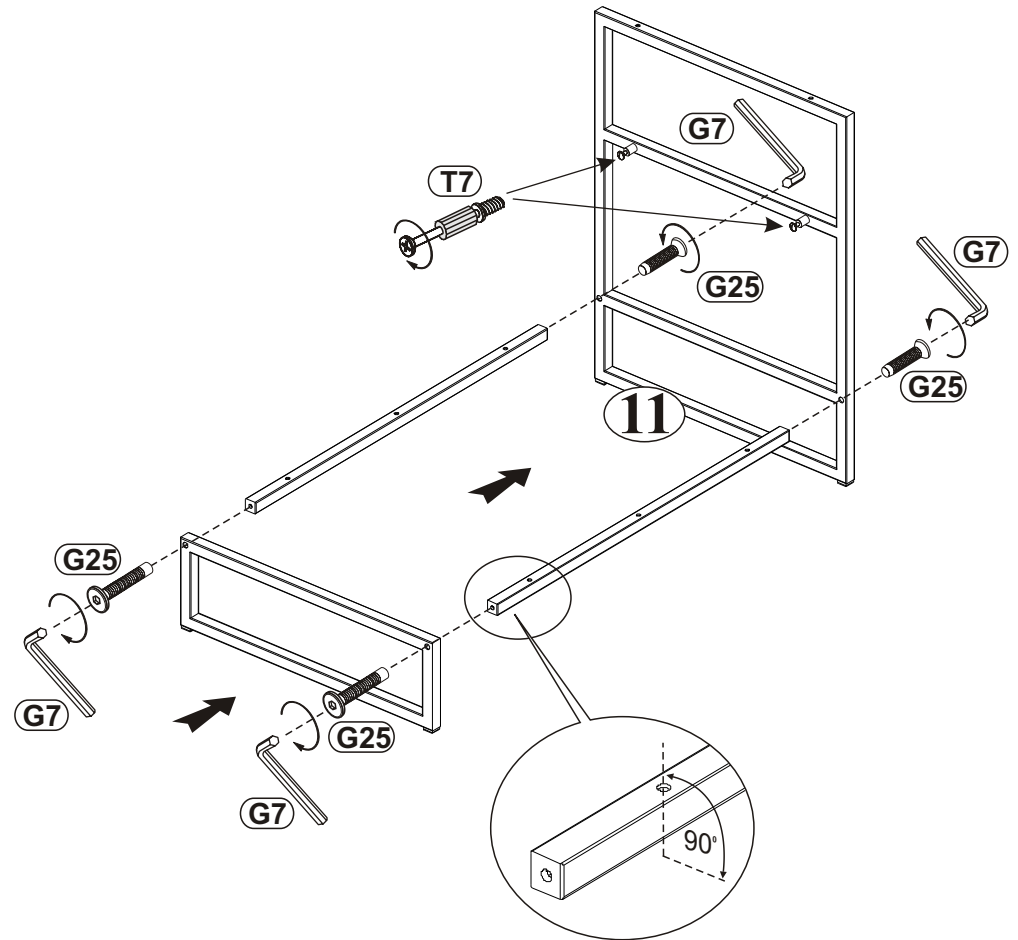

7

S26
4x25 x8

8

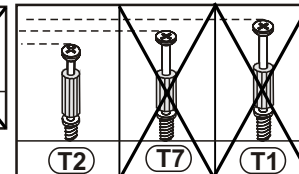
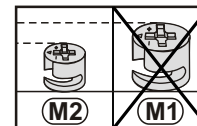

T2
5x32mm x2

M2
12x10mm x2

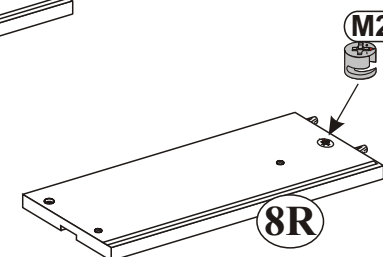
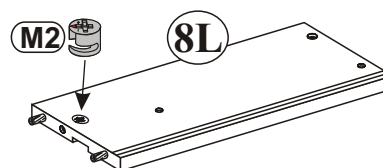
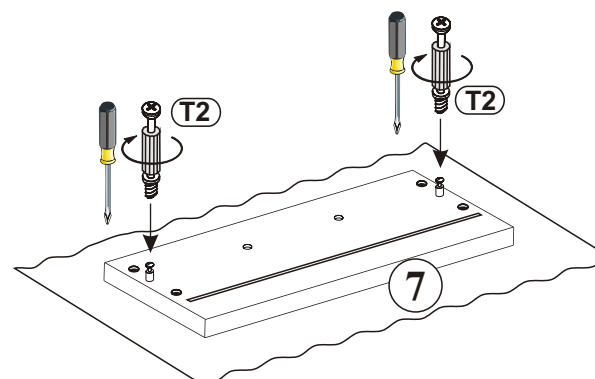
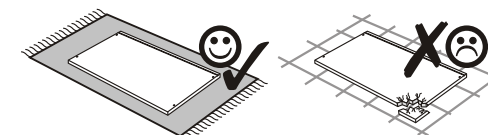
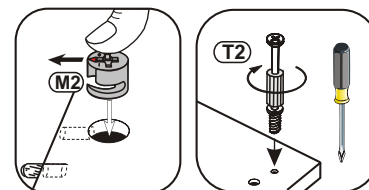
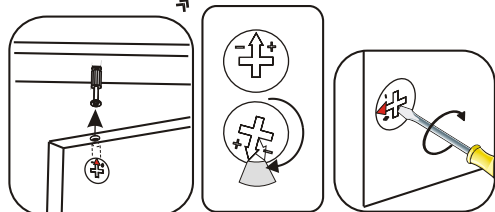
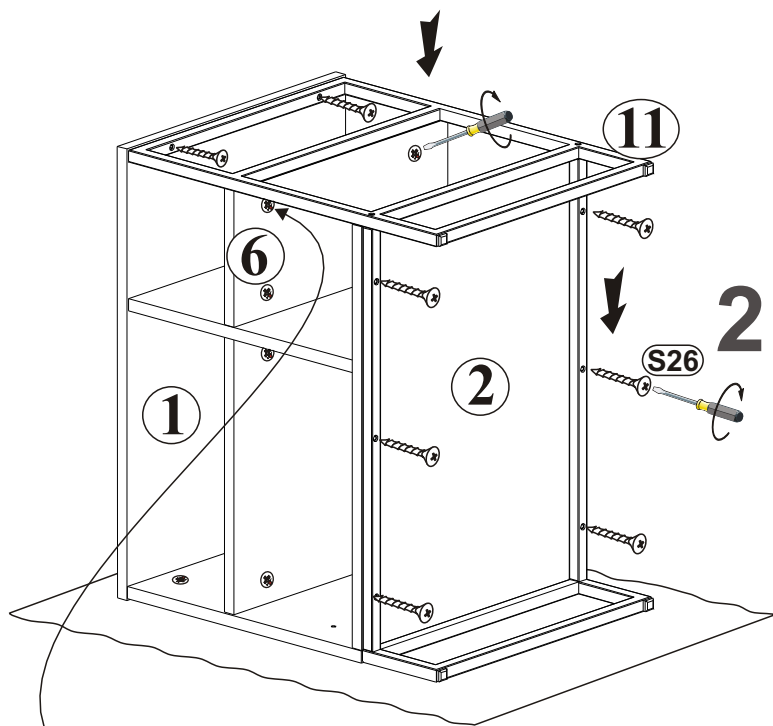

9

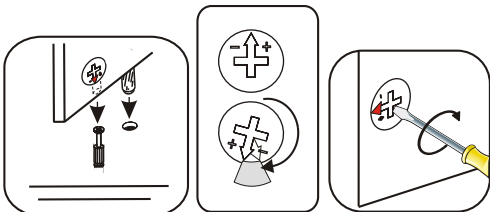
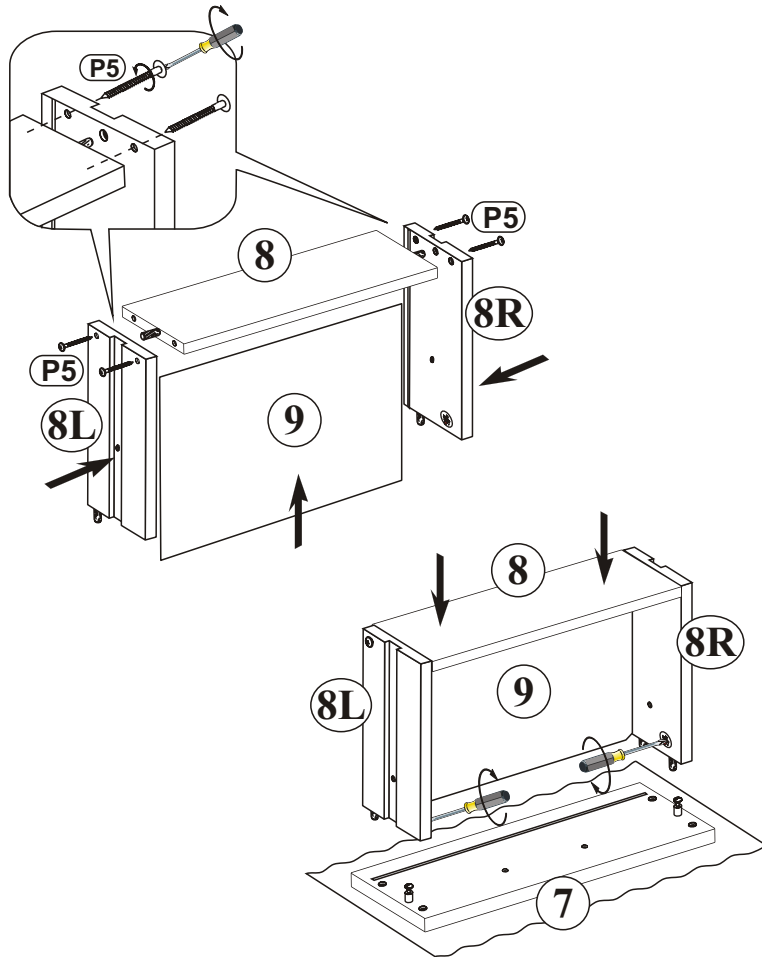
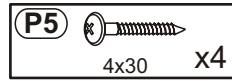
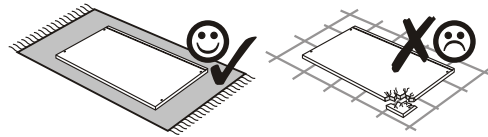

10

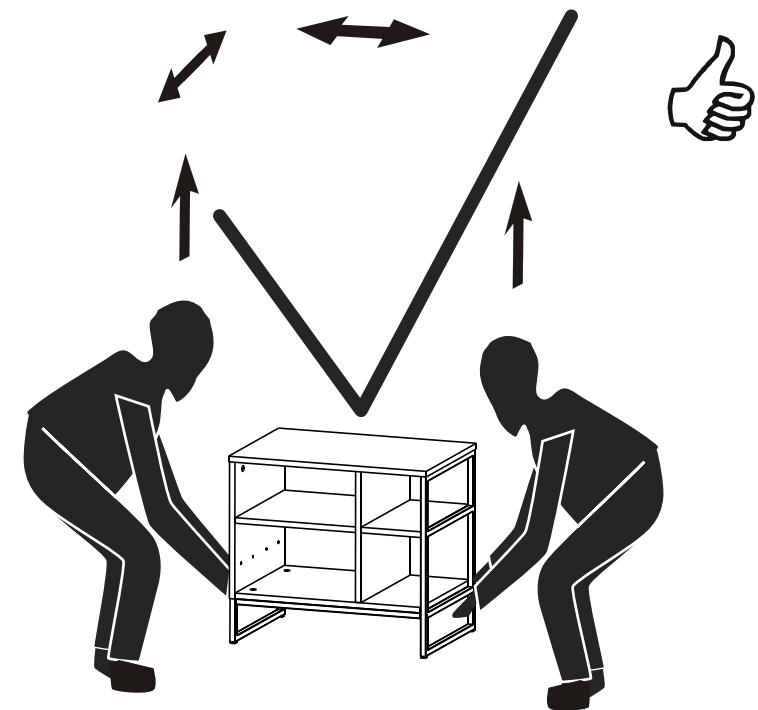
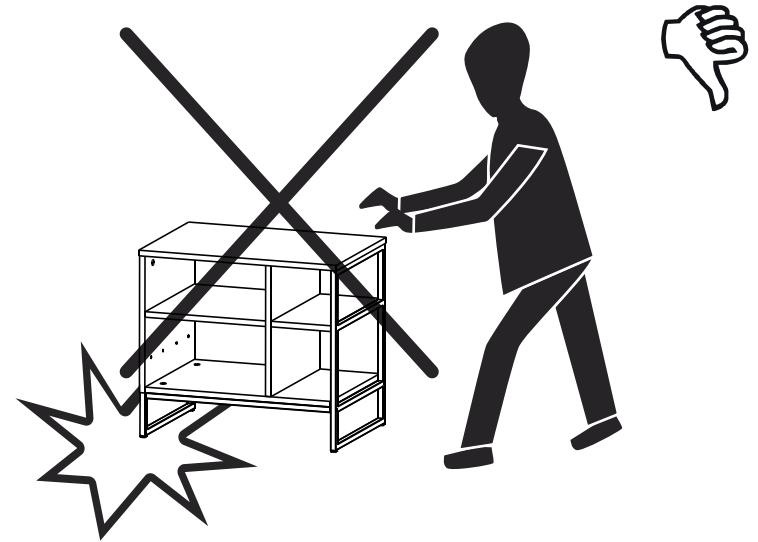

11

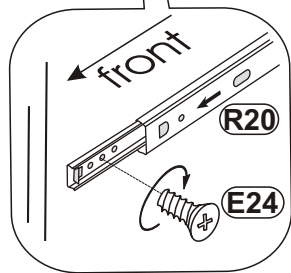
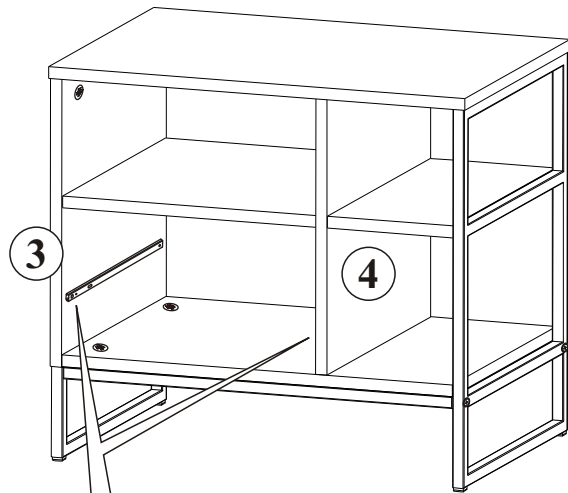
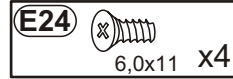
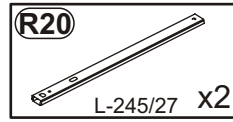
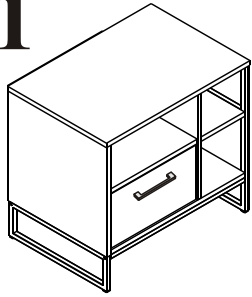

12

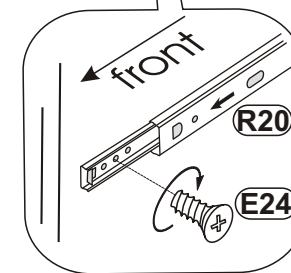
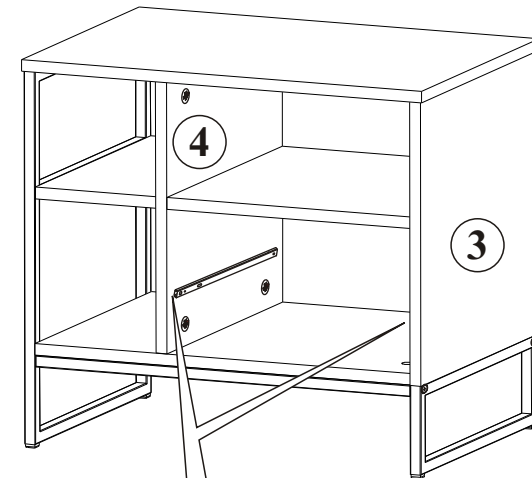
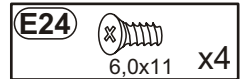
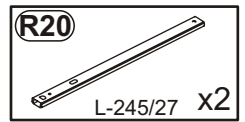
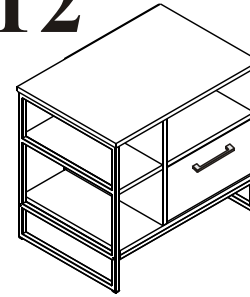

13

S6  3x20 x13

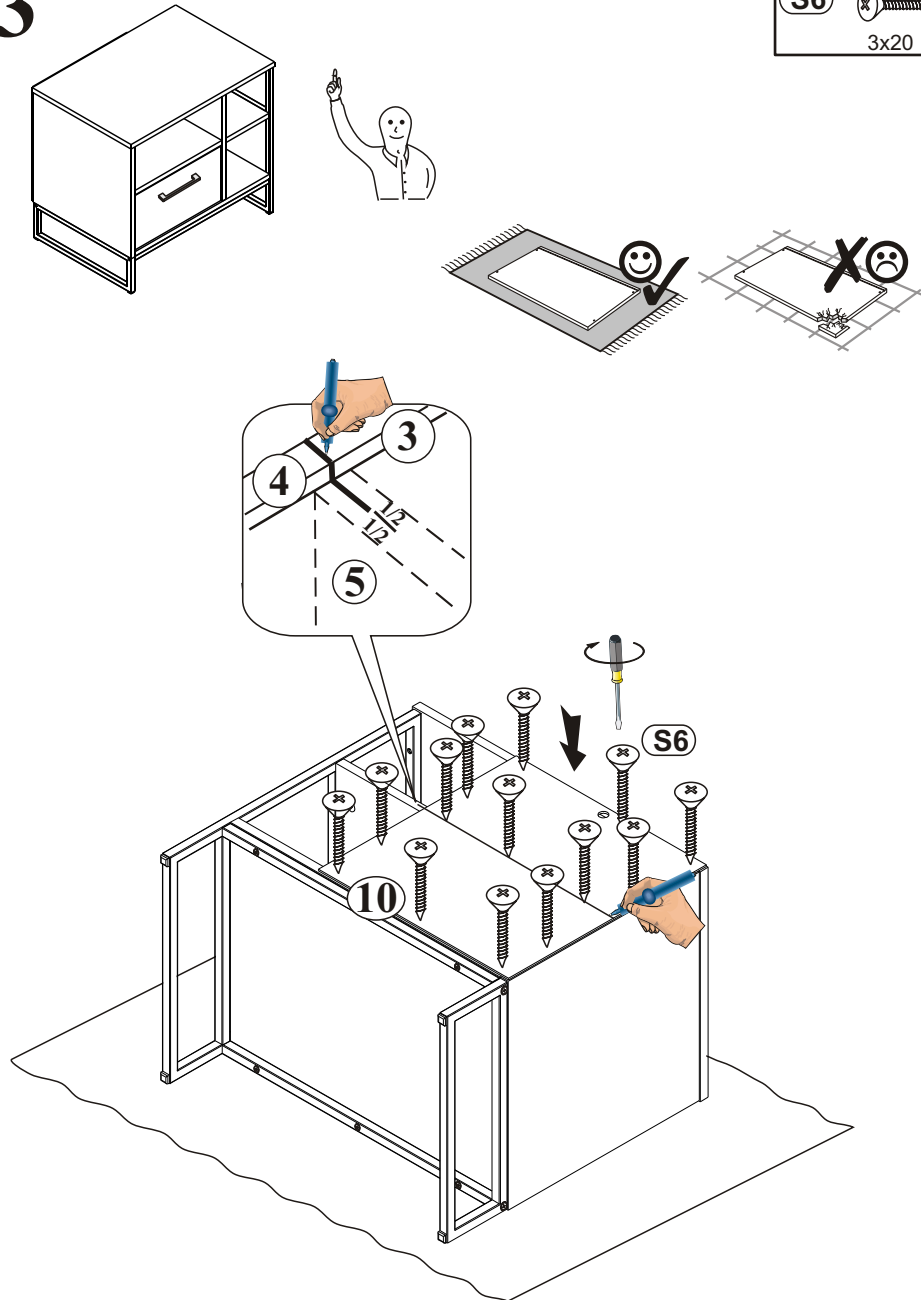

14

S6  3x20 x13

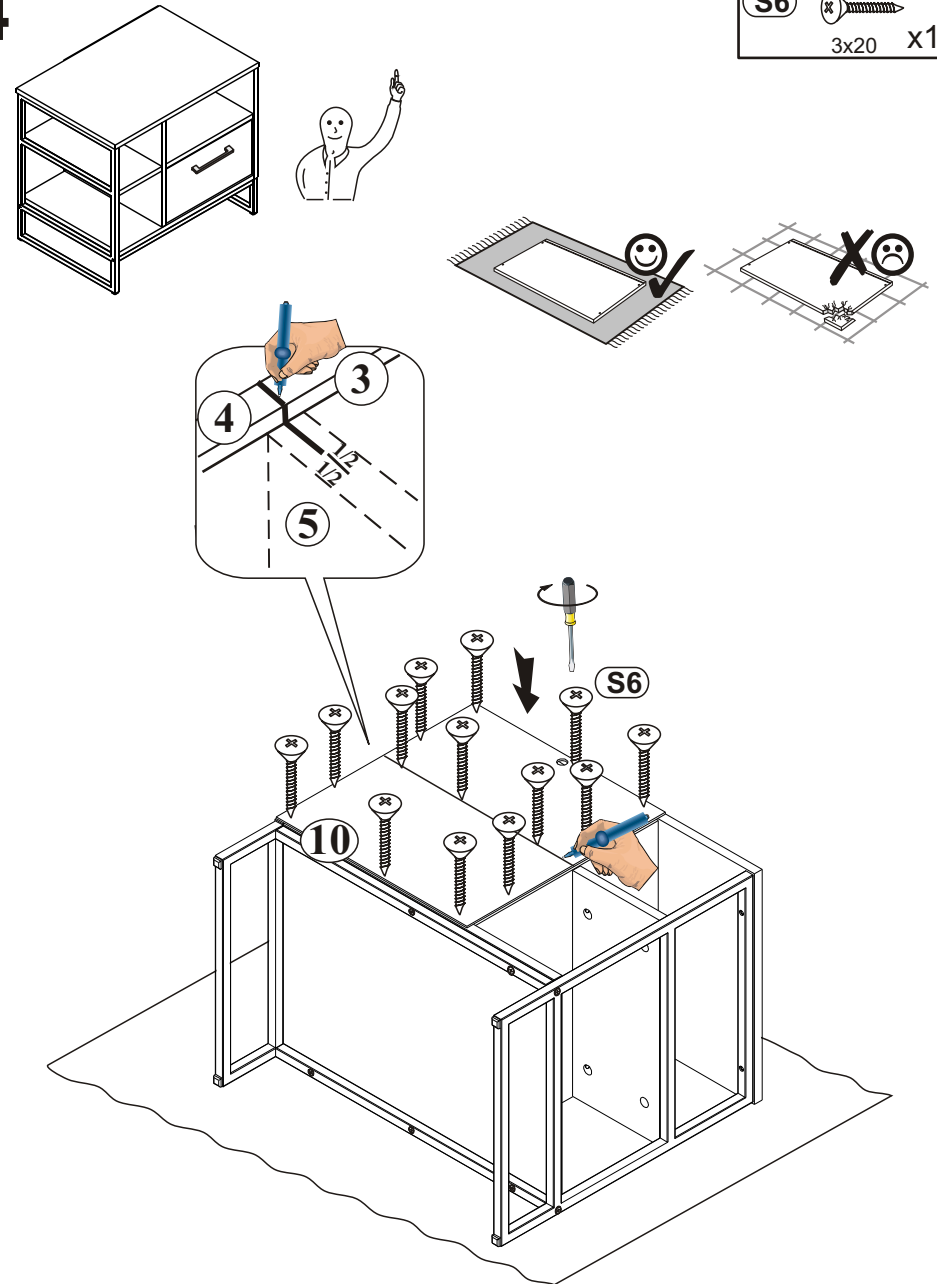

ROOF

38-591--8

11 / 12

15

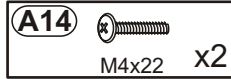
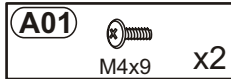
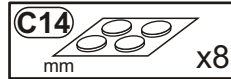
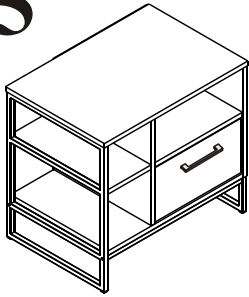

2

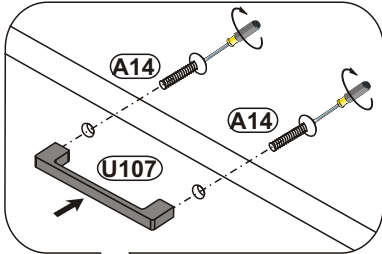

1

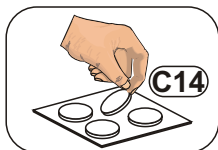
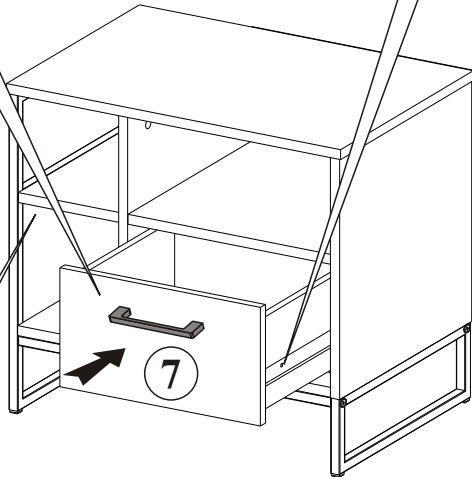
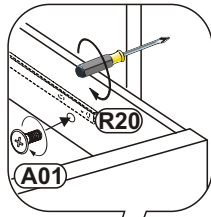

16

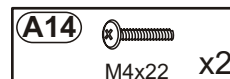
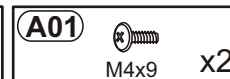
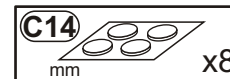
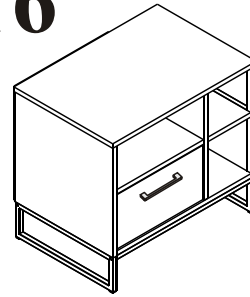

2

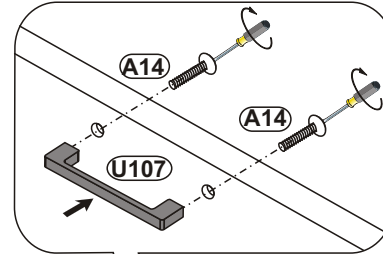

1

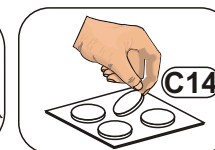
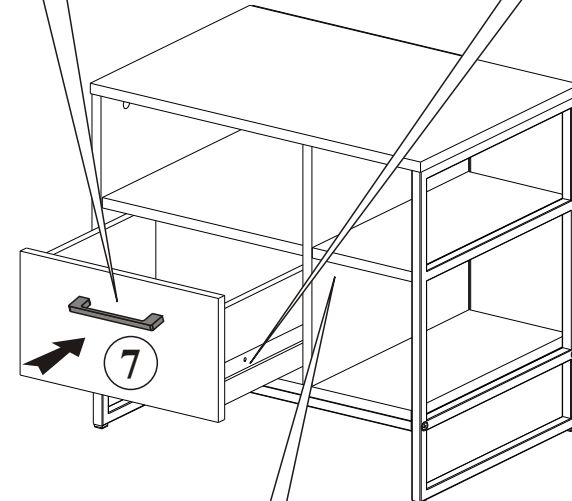
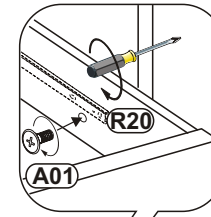

17

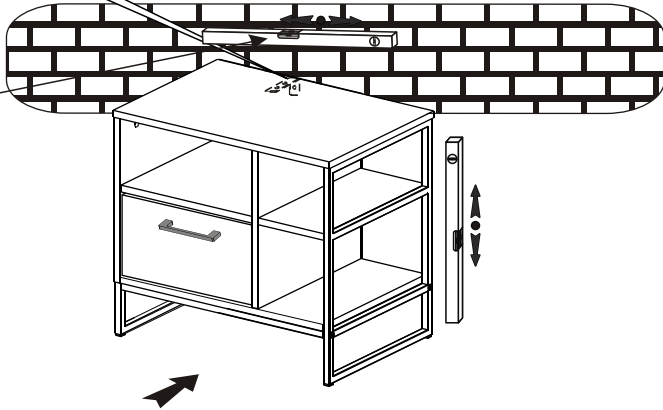
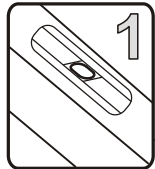
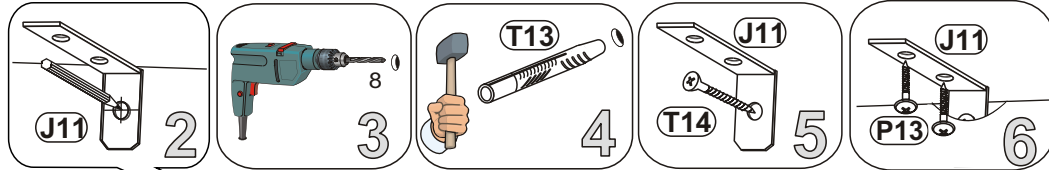
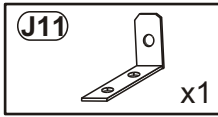
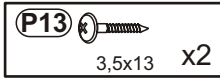

18

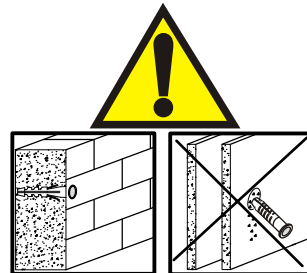
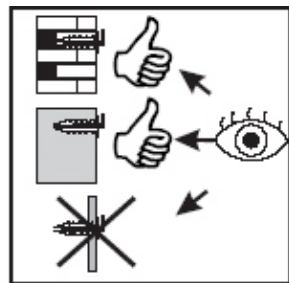
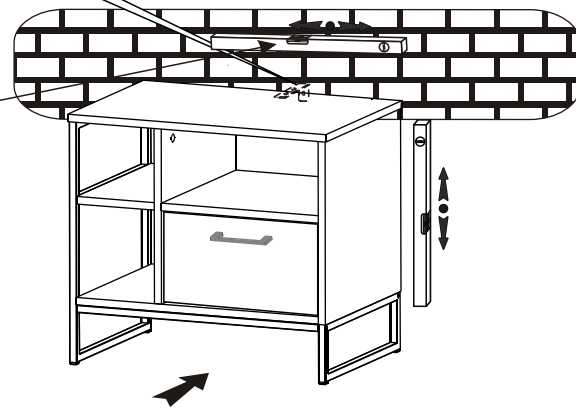
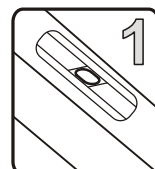
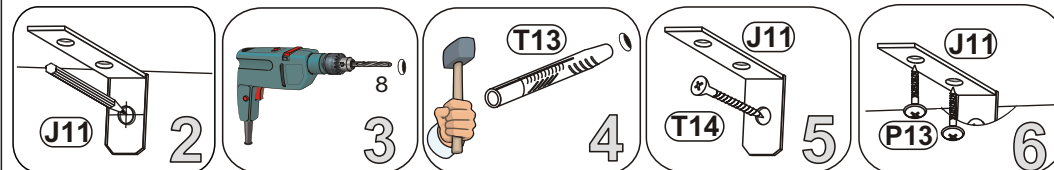
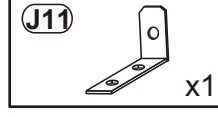
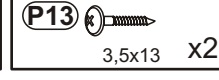
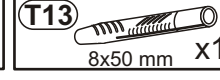
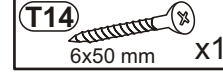

D CH AT LI LU Kleintelle und Verpackungsfolien bei der Möbelmontage von Kindern fernhalten!
GB US Keep small parts and plastic film out of the reach of children!
FR BE NC Tenir les petites pièces et les films plastiques hors de la portée des enfants!
NL Houid de kleine onderdelen en de plastic folie uit de buurt von kinderen!
IT Tenere i componenti di piccole dimensioni e le pellicole di plastica fuori dalla portata dei bambini!
SI Maljnih delov in embalažnih folije pri montaži pohištva hranite izven dosega otrok!
XS HR BA Male dijelove i foliju za pakovanje priklom montaže namještaja držite dalje od djece
HU Bitorzserelés közben a kis alkatrészek és a csomagoló fóliák gyermekéktől távol tartandók!
BG Дребни детайли и опаковъчни фолия да се държат далеч от деца при монтажа на мебелите!
CZ SK Vid montáži nábytku uchovávejte drobné díly a obalové fólie z dosahu dětí!
SE Vid möbelfmontering ska smådelar och förpackningsfolien hållas oåtkomliga för barn!
RO Țineți departe de copii piesele mici și folia de ambalat la montarea mobiliei!
ES ¡Durante el montaje, mantenga alejados de los niños las piezas pequeñas y el material plástico de embalaje!

D CH AT LI LU Möbelmontage muss auf ebennem Untergrund erfolgen. Bei Wandmontagen immer geeignetes Befestigungsmaterial verwenden.
GB US Furniture must be assembled on a flat surface. For assembly to the wall only use suitable fixing materials.
FR BE NC Le meuble doit être monté sur une surface plane. Pour le montage mural, utilisez des accessoires de fixation adaptés au type de mur.
NL De meubels dienen op een vlakke ondergrond te worden gemonteerd. Voor wandmontage moeten geschikte bevestigingsmaterialen worden gebruikt.
IT Il montaggio dei mobili deve avvenire su un fondo piano. Per il montaggio si prega di utilizzare solo materiali adatti.
SI Pohištvo je treba montirati na ravni podlagi. Pri stenski montaži vedno uporabite pritrilivni material.
XS HR BA Namještal se mora montirati na ravnoj podlozi. Kod montaže na zid uvijek koristite prikladan materijal za pričvršćivanje.
HU A bútor szerelését silk felületen kell végezni. Falra szereléshez mindig megfelelő rögzítianyagot kell használni.
BG Монтажът на мебелите да се извършва на равна основа. При стънен монтаж винаги да се използва подходящ крепежен материал.
CZ SK Montáž nábytku provádějte na rovinném podkladu. Při montáži na stěnu používejte vždy vhodný příslušovací materiál.
SE Montering av möbeln måste göras på jämnt underlag. Vid väggmontering ska lämpligt uppfästingsmaterial användas.
RO Montarea mobiliei trebuie să se realizeze pe o pardoseală dreaptă. La montarea la perete utilizați întotdeauna material de fixare adecvat.
ES El montaje debe efectuarse sobre una superficie uniforme. En el montaje mural emplee siempre el material de fijación adecuado.

D CH AT LI LU Bitte beachten Sie die Montageanleitung. Halten Sie immer die angegebene Wattzahl ein. Verhindern Sie einen Hitzestau.
GB US Please observe the assembly instructions. Do not exceed the max. given wattage. Ensure that the heat is not allowed to build up.
FR BE NC Veuillez respecter la notice de montage. Respectez impérativement le nombre des watts maximal. Veillez à éviter toute accumulation de chaleur.
NL Lees a.u.b. de montagehandleiding door. Houid u beslist aan het max. opgegeven wattage. Zorg ervoor dat geen hittestuwing onstaat.
IT Attenersi alle istruzioni di montaggio. Rispettarsi rigorosamente il numero di watt max. indicato. Assicurarsi che non si verifichi un accumulo di calore.
SI Upoštevajte navodila za montažo. Vedno upoštevajte navedeno število vatov. Preprečite zastoj vročine.
XS HR BA Obratite pažnju! Vas pozor na uputu za montažu. Uvijek se pridržavajte navedenog broja vati. Izbjegavajte zastoj vrućine.
HU Vegye figyelembe a szerelési útmutatót. Mindig tartsa be a megadott wattszámot. Akadályozza meg a hőelődést.
BG Моля, вземете под внимание ръководството за монтаж. Спазвайте винаги посочените ватове. Избягвайте акумулиране на топлина.
CZ SK Dodržujte prosím návod k montáži. Vždy dodržujte uvedenou hodnotu výkonu (watt). Zabraňte tak přehřívání.
SE Följ monteringsanvisningen. Följ alltid angivet wattal. Undvik att hetta uppstår.
RO Respectați instrucțiunile de montaj. Respectați întotdeauna numărul de watt impus. Evitați acumularea de căldură.
ES Le rogamos que tenga presente las instrucciones de montaje. Respete siempre el número indicado de vatios. Evite la acumulación de calor.

D CH AT LI LU Halten Sie die max. zulässigen Belastungswerte der Möbelteile ein. Details siehe Montageanleitung
GB US Comply with the max. permissible loads. For details, please refer to the assembly instructions
FR BE NC Respectez les valeurs de charge max. admissibles des parties de meubles. Pour plus de détails, cf. la notice de
NL Houid de maximaal geoorloofde belastingwaarden van de meubeldelen aan. Voor details verwijzen wij naar de montagehandleiding
IT Rispettare la portata max. permessa degli elementi del mobile. Per dettagli si vedano le istruzioni di montaggio e si vada
SI Upoštevajte največjo dovoljeno obremenitev delov pohištva. Podrobnosti najdete v navodilih za montažo in na
XS HR BA Tartsa be a bútor elemek max. megengedett terhelési értékeit. A részleteket lásd a szerelési útmutatóban
HU Tartsa be a bútor elemek max. megengedett terhelési értékeit. A részleteket lásd a szerelési útmutatóban
BG Спазвайте макс. допустимите стойности на натоварване на мебелите. За подробности виж ръководството за монтаж
CZ SK Dodržujte max. přípustné hodnoty zatížení nábytkových dílů. Podrobnosti viz návod k montáži
SE Följ max. tillåtnen belastning av möbeldelarna. Mer information finns i monteringsanvisningen
RO Respectați valorile de solicitare max. admise pentru corpurile de mobilier. Pentru detalii consultați instrucțiunile de montaj
ES Respete los valores máximos de carga admisibles para las piezas de los muebles. Consulte los detalles en las instrucciones

D CH AT LI LU Zur Möbelreinigung ein mit Wasser befeuchtetes, fusselfreies Baumwolltuch verwenden. Gereinigte Flächen immer trockenreiben!
GB US To clean the furniture only use a water dampened lint-free cotton cloth. Once cleaned, always wipe the surfaces dry.
FR BE NC Utilisez un chiffon en coton non pelucheux humidifié avec de l'eau pour nettoyer les meubles. Séchez systématiquement les surfaces
NL nettooyes en les frottant!
IT Gebruik een met water bevochtigde, pluïsvrije katoenen doek om de meubels te reinigen. Wrijf gereinigde oppervlakken altijd droog!
SI Per pulire il mobile utilizzare un panno di cotone inumidito d'acqua e che non perde pelucchi. Asciugare sempre le superfici che si sono
XS HR BA puštile!
HU Za čišćenje pohištva uporabljajte vlažno bombažno krpo. Ki ne pušča vlaken. Očišćene površine vedno obrišite do suhlega!
BG За чišćenje namještaja koristite sa vodom navlaženpu pamučnu krpu koja ne ispušta vlakna. Očišćene površine uvijek obrišite suhom krpom!
CZ SK Bůtortisztáshoz vizzel benedvesített, nem szárlázódó pamukkenőt használjon. A megtisztított felületeket mindig törőlje szárazra!
HU Za polirstvanje na mebelite ispolozavajte navlaženana s voda, neizgluskašča vlakna pamučna krpa. Počistćenije površnosti vinaghi da se izprivaat do suhoi!

CZ SK K čišćení nábytku používejte bavlněný hadr neuvloňující vlákna, navlžený ve vodě. Učišćeně plochy vždy utřete do sucha!
SE För möbelfrengöning används en luddfri bomullscduk fuktad med vatten. Rengjörda ytor ska alltid torkas torra!
RO Pentru curățarea mobiliei utilizați o lavetă din bumbac fără scame umezită cu apă. Suprafețele curățate se șterg întotdeauna până se usucă!
ES Emplee un paño de algodón humedecido con agua y libre de pelusa para la limpieza de los muebles. ¡Seque siempre las superficies que ha limpiado!