

INDICE A - 01/03/2019

PRADO 3615 LIT 140 N°18 Réf: 18CC0314

PRADO 4381 LIT 140 N°18 Réf: 18CD0314

PRADO 3615 LIT 160 N°19 Réf: 18CC0316

PRADO 4381 LIT 160 N°19 Réf: 18CD0316

PRADO 3615 LIT 180 N°20 Réf: 18CC0318

PRADO 4381 LIT 180 N°20 Réf: 18CD0318

NOTICE DE MONTAGE

ASSEMBLING INSTRUCTIONS

MONTAGEANLEIUNG

MANUAL DE MONTAJE

MONTAGEVOORSCHRIFT

INSTRUÇÕES DE MONTAGEM

ISTRUZIONI DI MONTAGGIO

ИНСТРУКЦИЯ ПО СБОРКЕ

Naputci za montažu

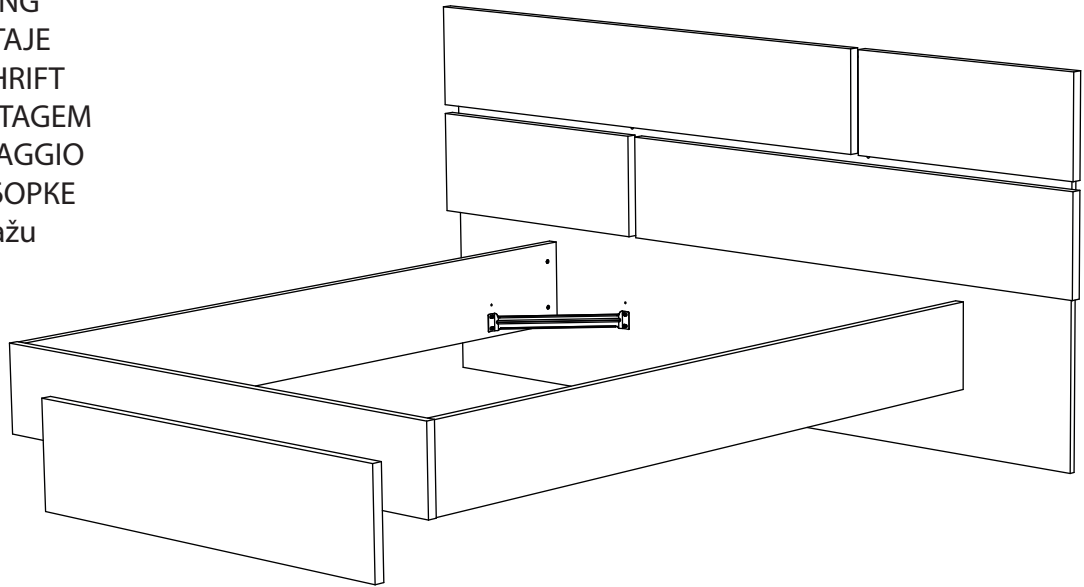

1H30

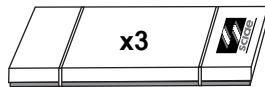

x3



Package 1: 34 Kg

Package 2: 40 Kg

Package 3: 16 Kg

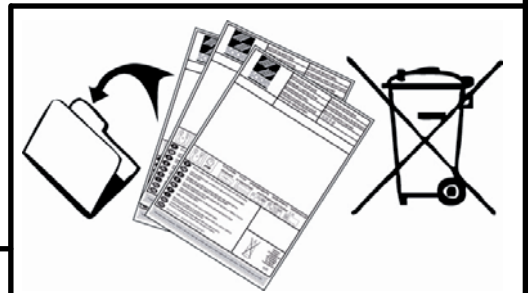

F POUR L'APRES-VENTE, RETOURNEZ AU MAGASIN AVEC CETTE NOTICE

GB FOR THE AFTER SALES, GO BACK TO THE SHOP WITH THIS ASSEMBLY INSTRUCTION

D WENDEN SIE SICH BITTE AN IHREN HANDLER UND GEBEN SIE IHM DIE KENNUMMER DES MOBELS UND DIE TEILNUMMER

E EN CASO DE SERVICIO POST-VENTA DEBEN DE VOLVER A LA TIENDA CON LAS INSTRUCCIONES DE MONTAJE

NL VOOR SERVICE NA VERKOOP, GA NAAR UW LEVERANCIER MET DEZE MONTAGE HANDLEIDING

P PARA O POS VENDA, VOLTE A LOJA COM ESTA FOLHA

I SERVIZIO POST VENDITA: E NECESSARIO PRESENTARSI SUL PUNTO VENDITA CON QUESTE ISTRUZIONI DI MONTAGGIO

RU ДЛЯ ПОСЛЕПРОДАЖНОГО ОБСЛУЖИВАНИЯ ПРОСЬБА ОБРАТИТЬСЯ В МАГАЗИН ПРЕДЪЯВИВ НАСТОЯЩУЮ ИНСТРУКЦИЮ ПО СБОРКЕ

HR U SLUČAJU REKLAMACIJE, VRATITE SE NA PRODAJNO MJESTO S OVIM UPUTAMA ZA MONTAŽU

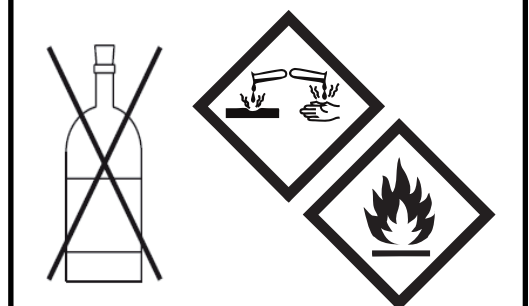
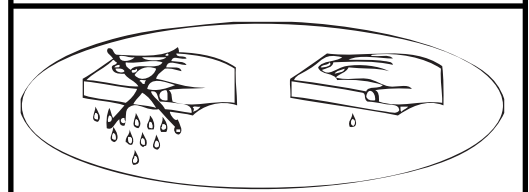

	+40°C +104°F	
	HYGROMETRIE HYGROMETRY 40%-65%	
	+15°C +59°F	

1 an
1 year

OK

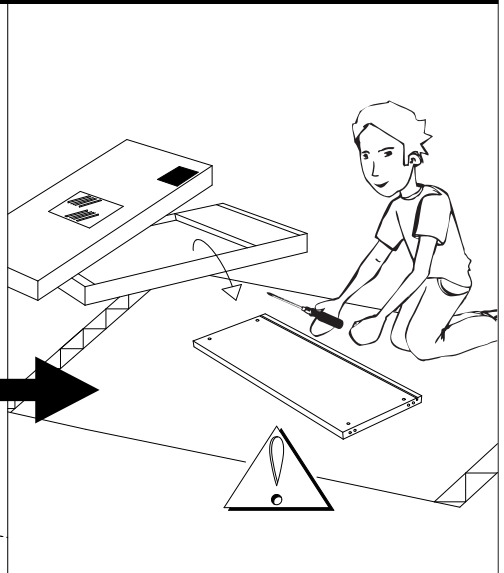
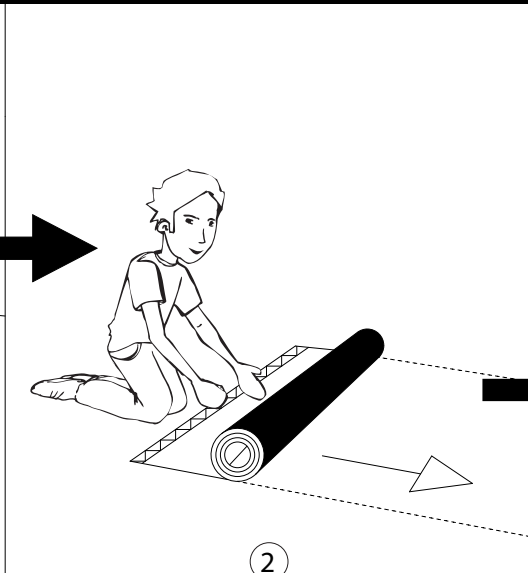
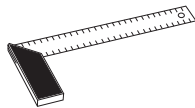
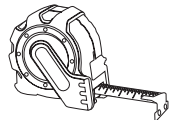
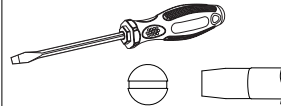
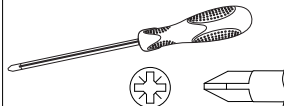
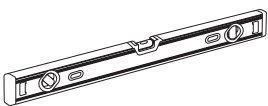
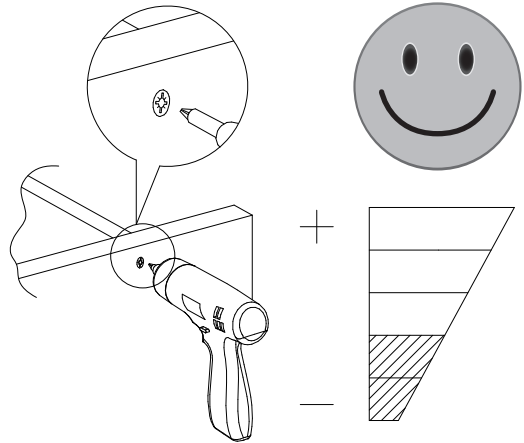
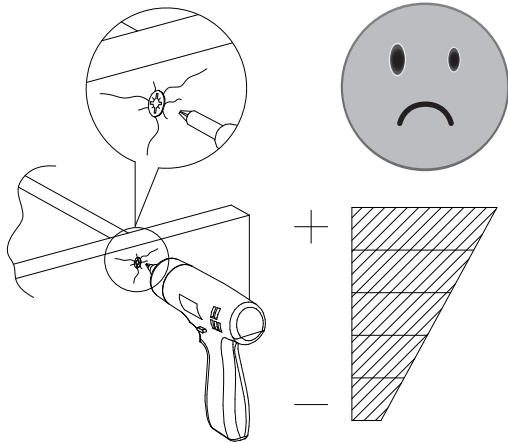
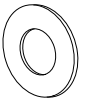
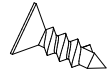
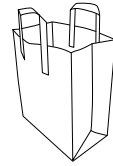
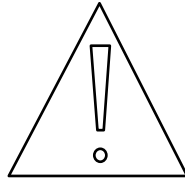

1

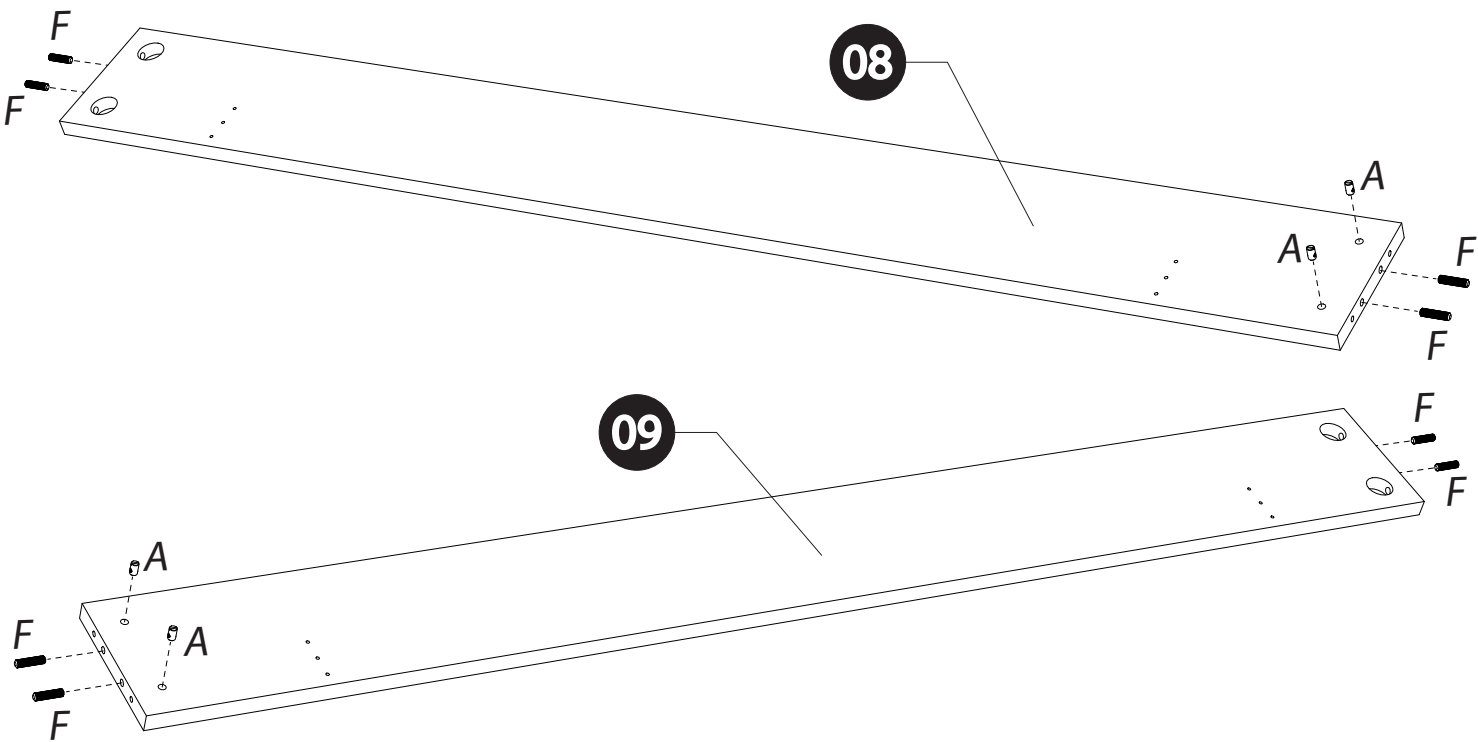
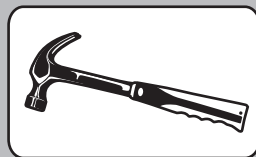
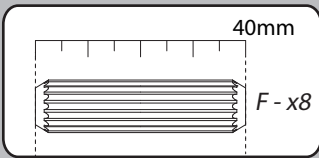
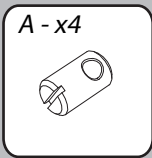

2

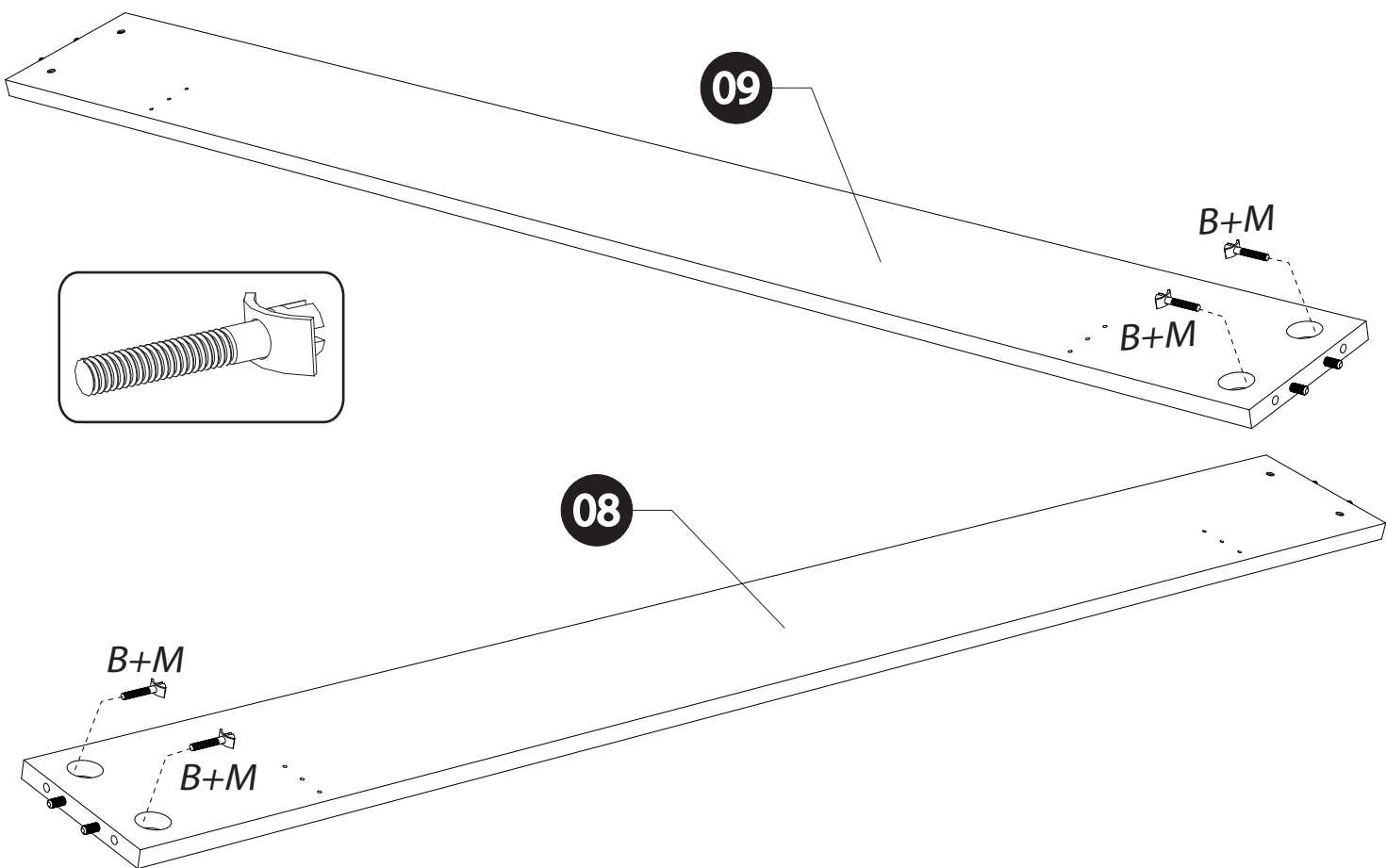
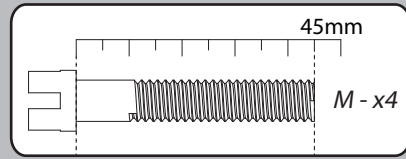
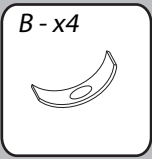

3

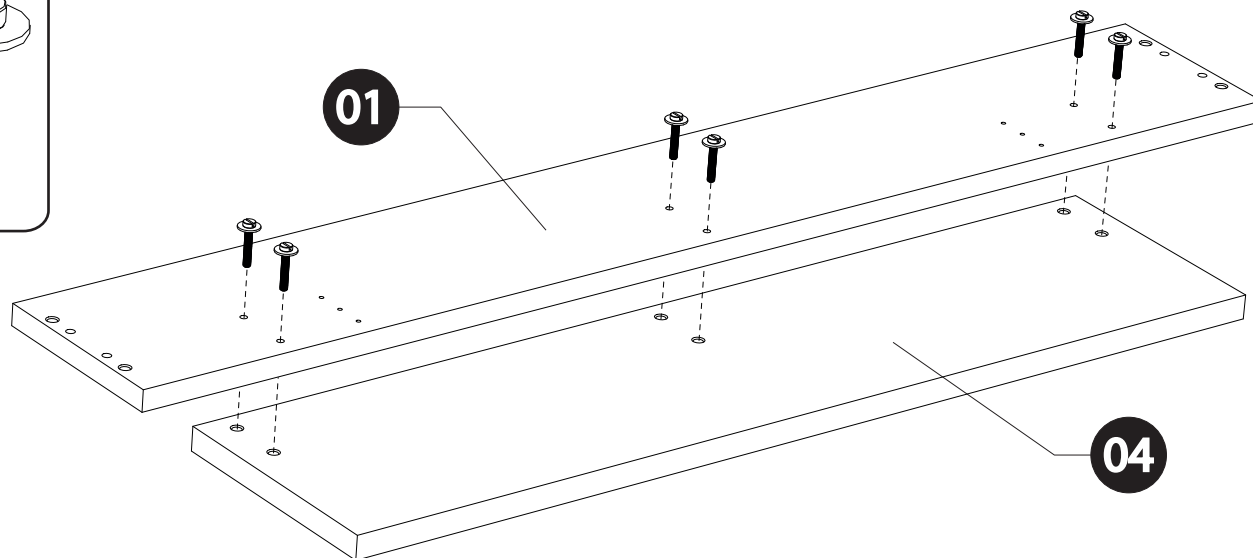
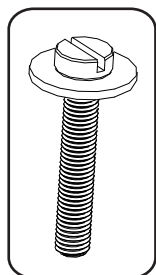
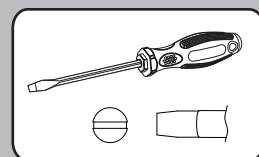
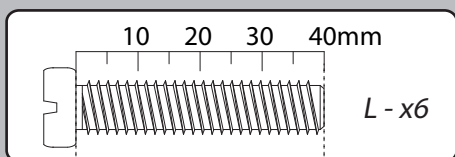
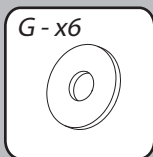



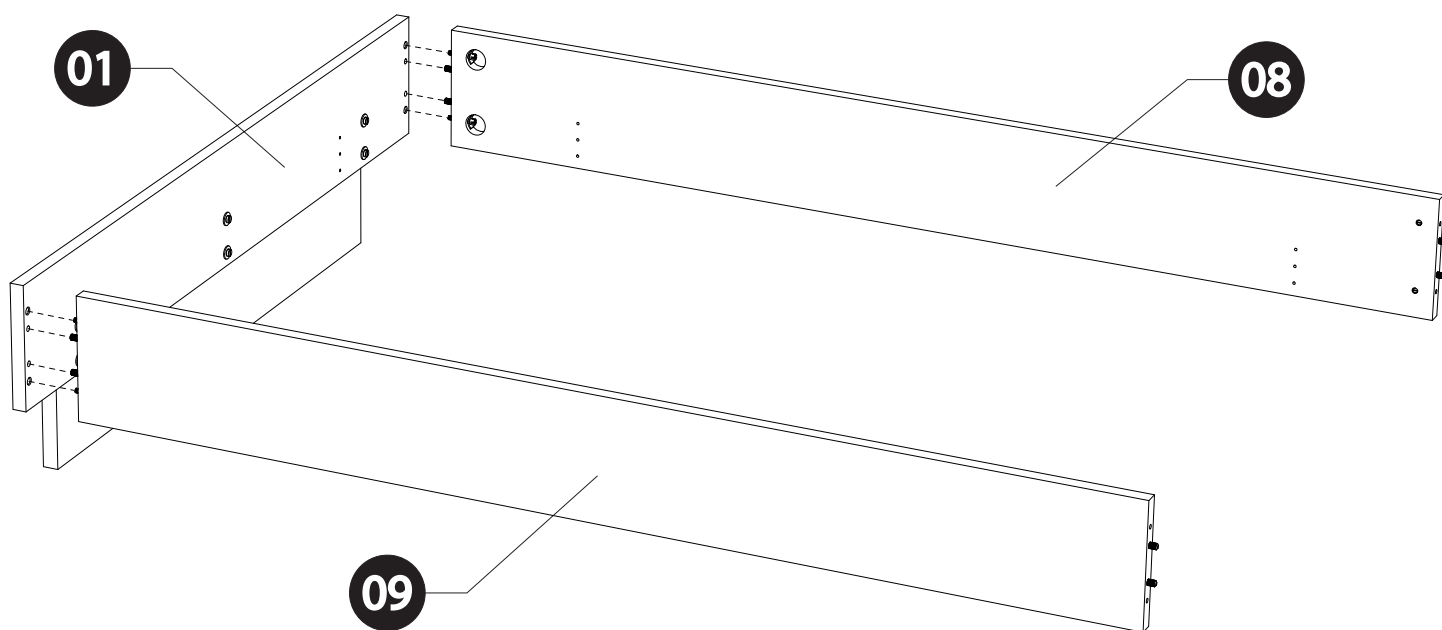
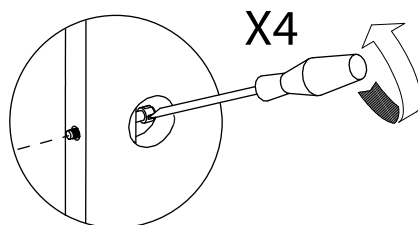
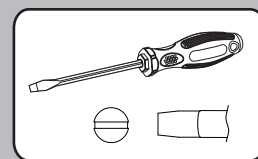
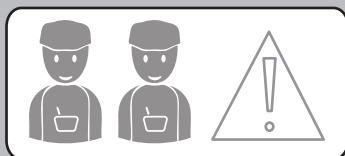

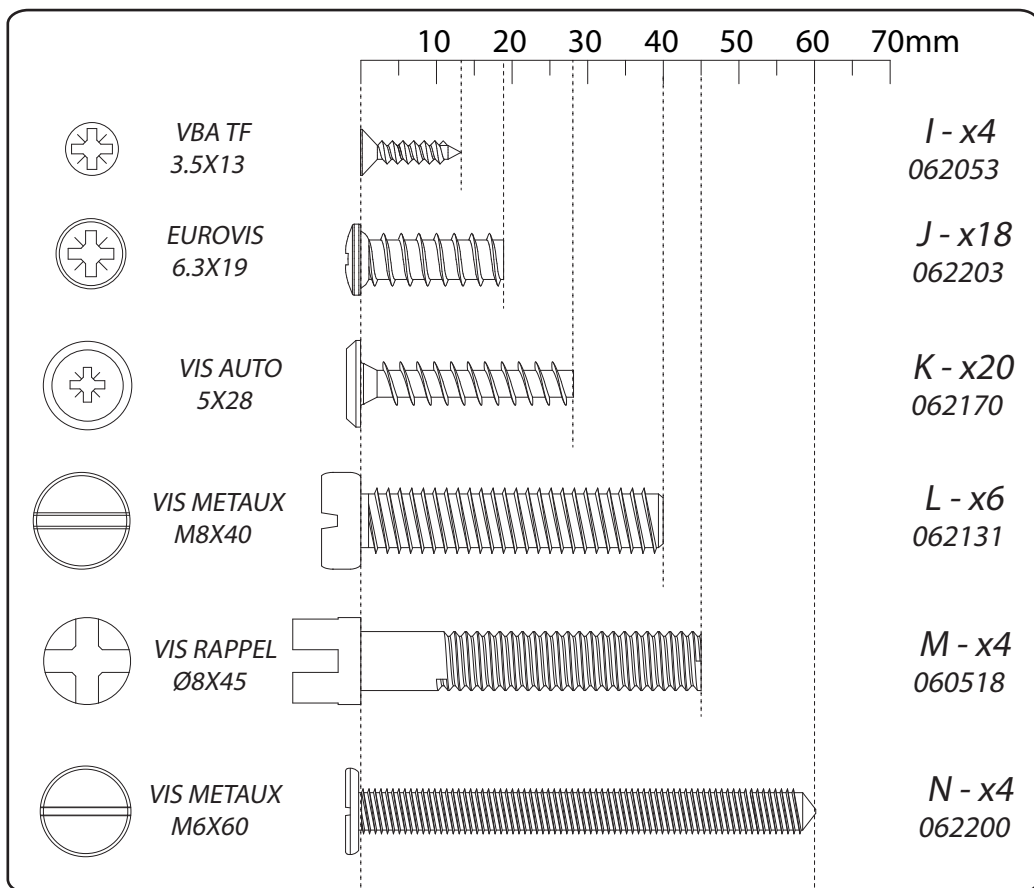
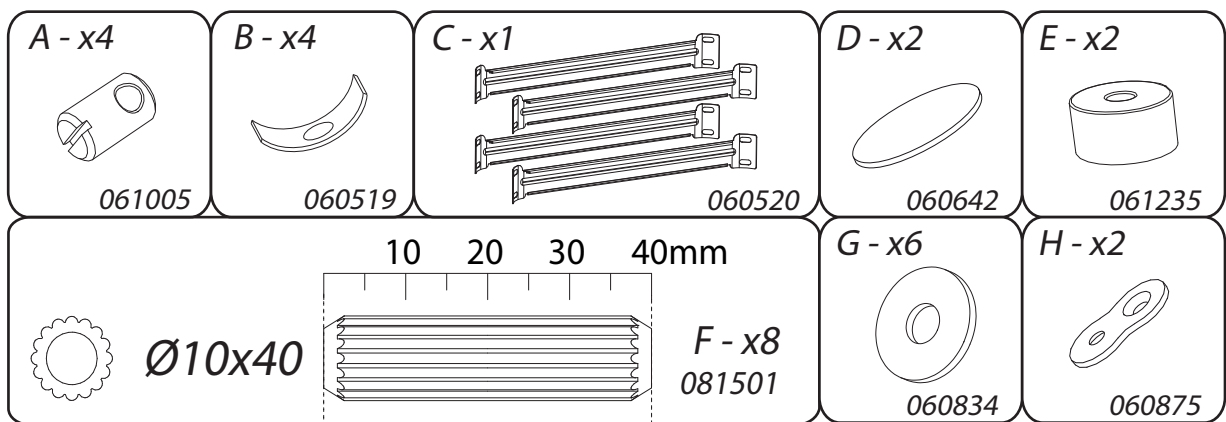

4

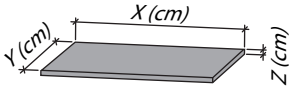
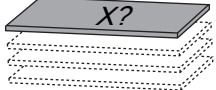
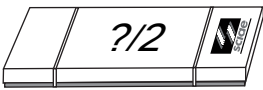



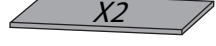





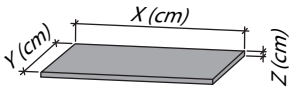
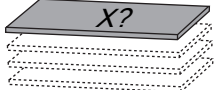
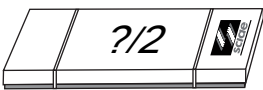

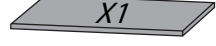



LIT 140 N°18

<i>DESIGNATION</i>		<i>N°</i>		
Pied de lit	146.2 x 23 x 2.5	1		2
Habillage de pied	116.2 x 28.5 x 2.8	4		1
Panneau bas de tête	215 x 58.7 x 1.6	7		2
Habillage long de tête	148 x 27.5 x 2.8	12		1
Habillage court de tête	69.5 x 27.5 x 2.8	13		1
Panneau haut de tête	215 x 41.3 x 1.6	14		2

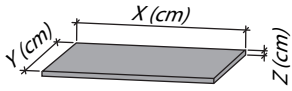
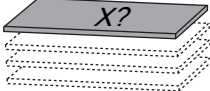
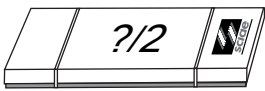

LIT 160 N°19

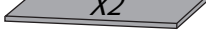
<i>DESIGNATION</i>		<i>N°</i>		
Pied de lit	166.2 x 23 x 2.5	1		2
Habillage de pied	136.2 x 28.5 x 2.8	4		1
Panneau bas de tête	215 x 58.7 x 1.6	7		2
Habillage long de tête	148 x 27.5 x 2.8	12		1
Habillage court de tête	69.5 x 27.5 x 2.8	13		1
Panneau haut de tête	215 x 41.3 x 1.6	14		2
Traverse support literie	159.6 x 11 x 3	17		2

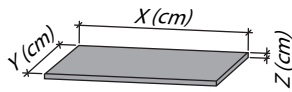
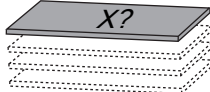
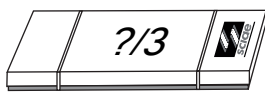

LIT 180 N°20

<i>DESIGNATION</i>		<i>N°</i>		
Pied de lit	186.2 x 23 x 2.5	1		2
Habillage de pied	156.2 x 28.5 x 2.8	4		1
Panneau bas de tête	215 x 58.7 x 1.6	7		2
Habillage long de tête	148 x 27.5 x 2.8	12		1
Habillage court de tête	69.5 x 27.5 x 2.8	13		1
Panneau haut de tête	215 x 41.3 x 1.6	14		2
Traverse support literie	179.6 x 11 x 3	17		2

PANS 190

<i>DESIGNATION</i>		<i>N°</i>		
Pan gauche	191 x 22.8 x 2.5	8		3
Pan droit	191 x 22.8 x 2.5	9		3

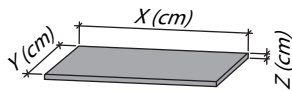
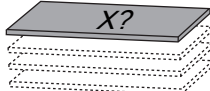
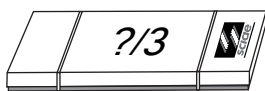
PANS 200

<i>DESIGNATION</i>		<i>N°</i>		
Pan gauche	201 x 22.8 x 2.5	8		3
Pan droit	201 x 22.8 x 2.5	9		3

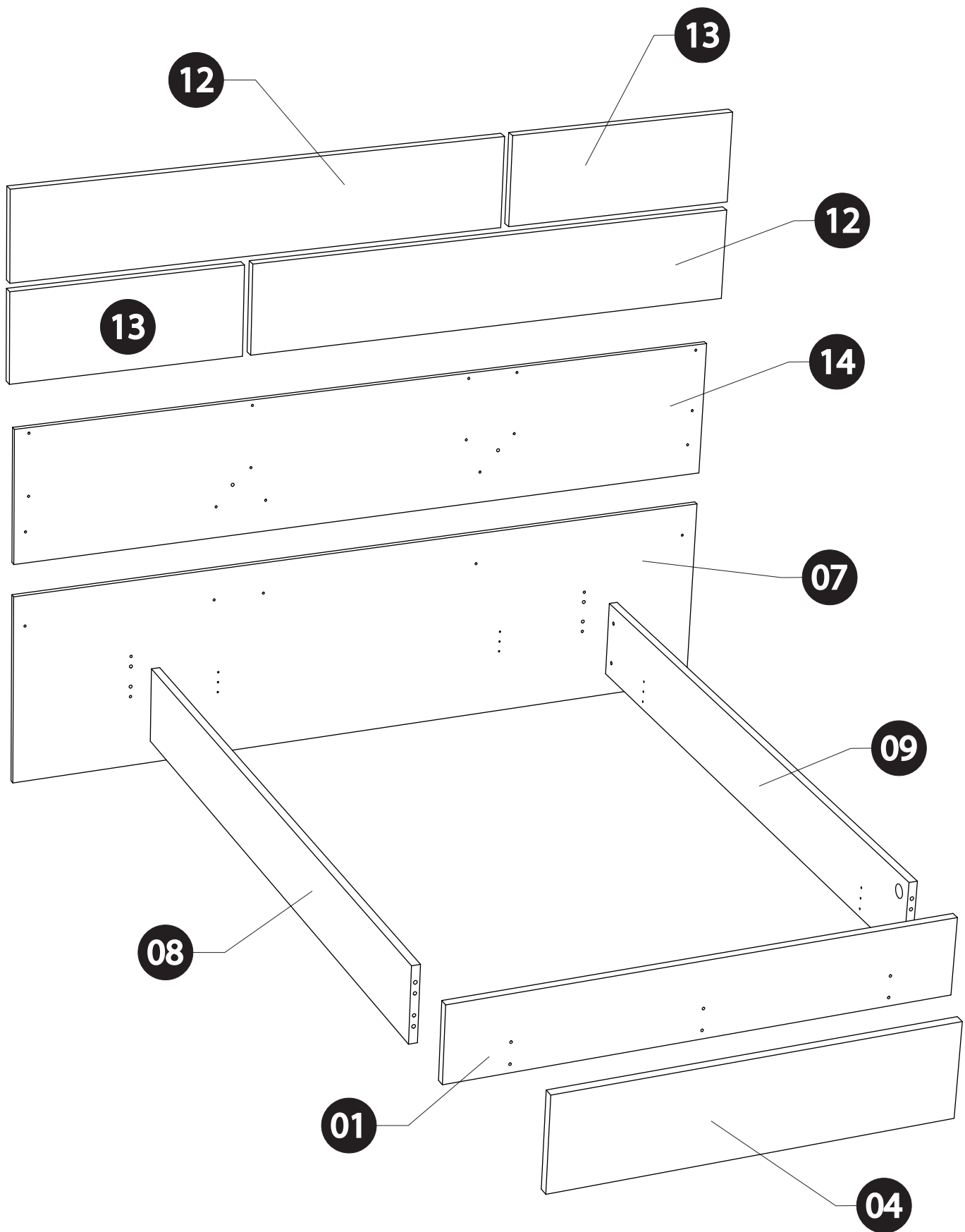

5

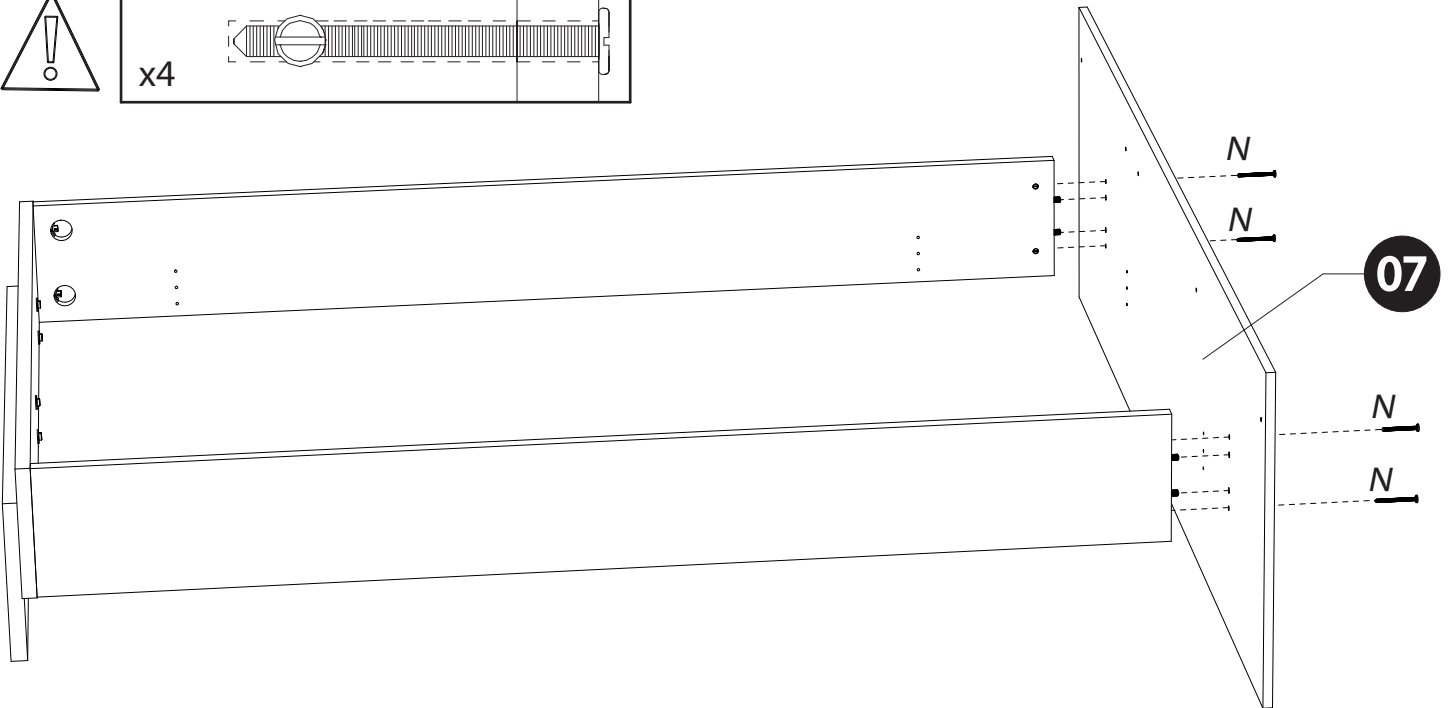
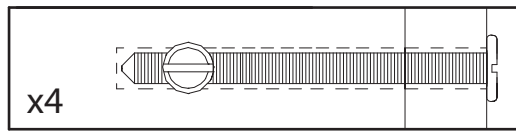
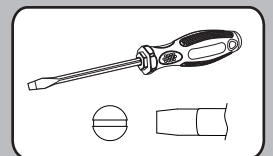
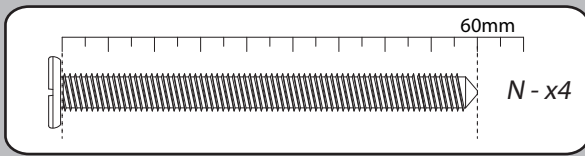

6

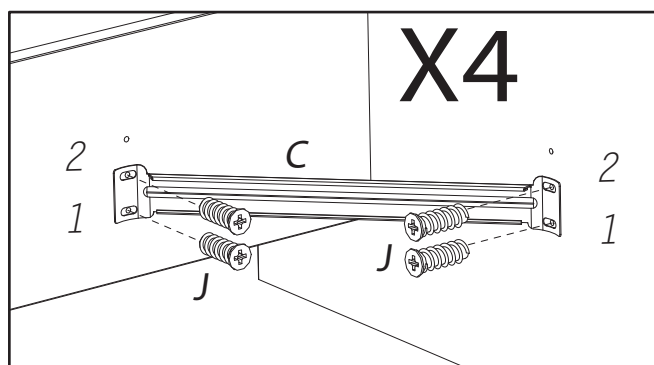
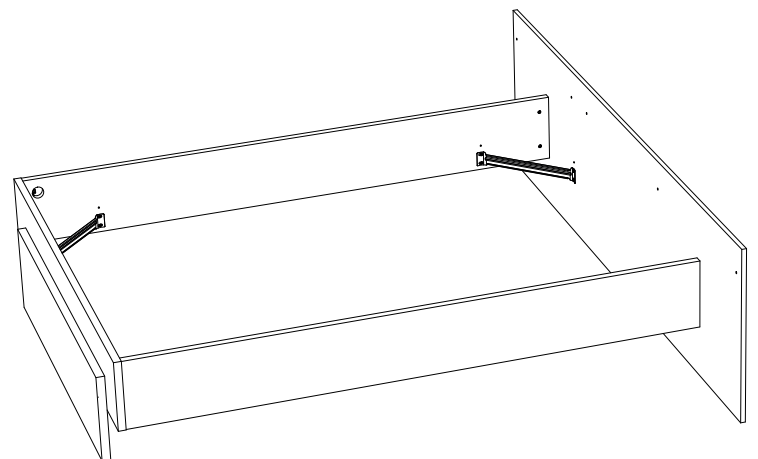
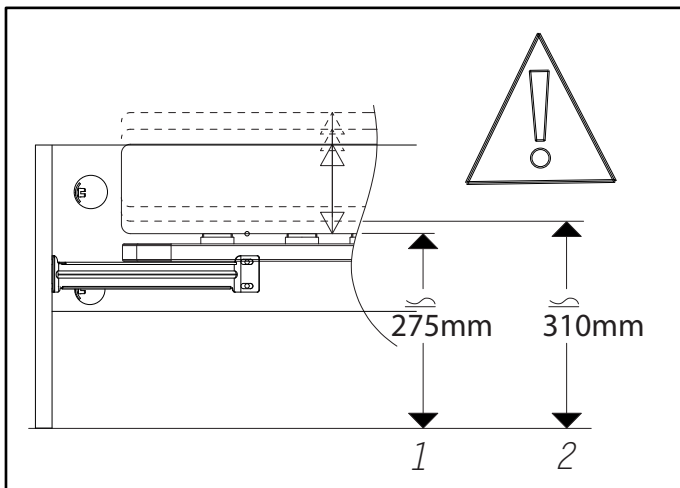
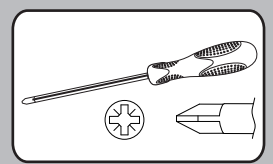
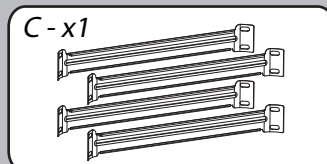
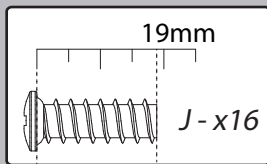

7

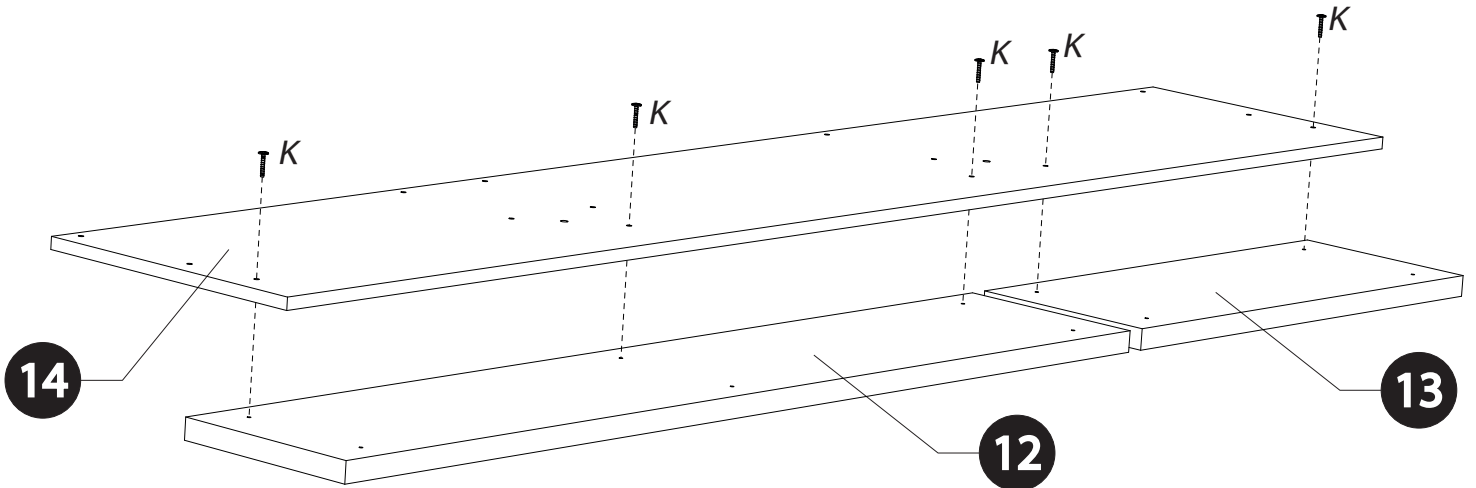
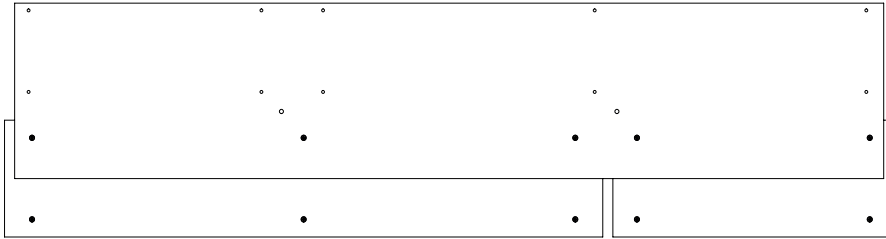
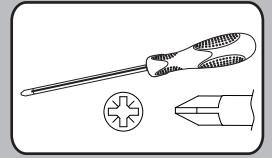
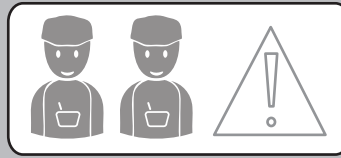
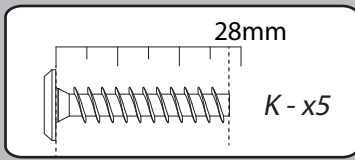

8

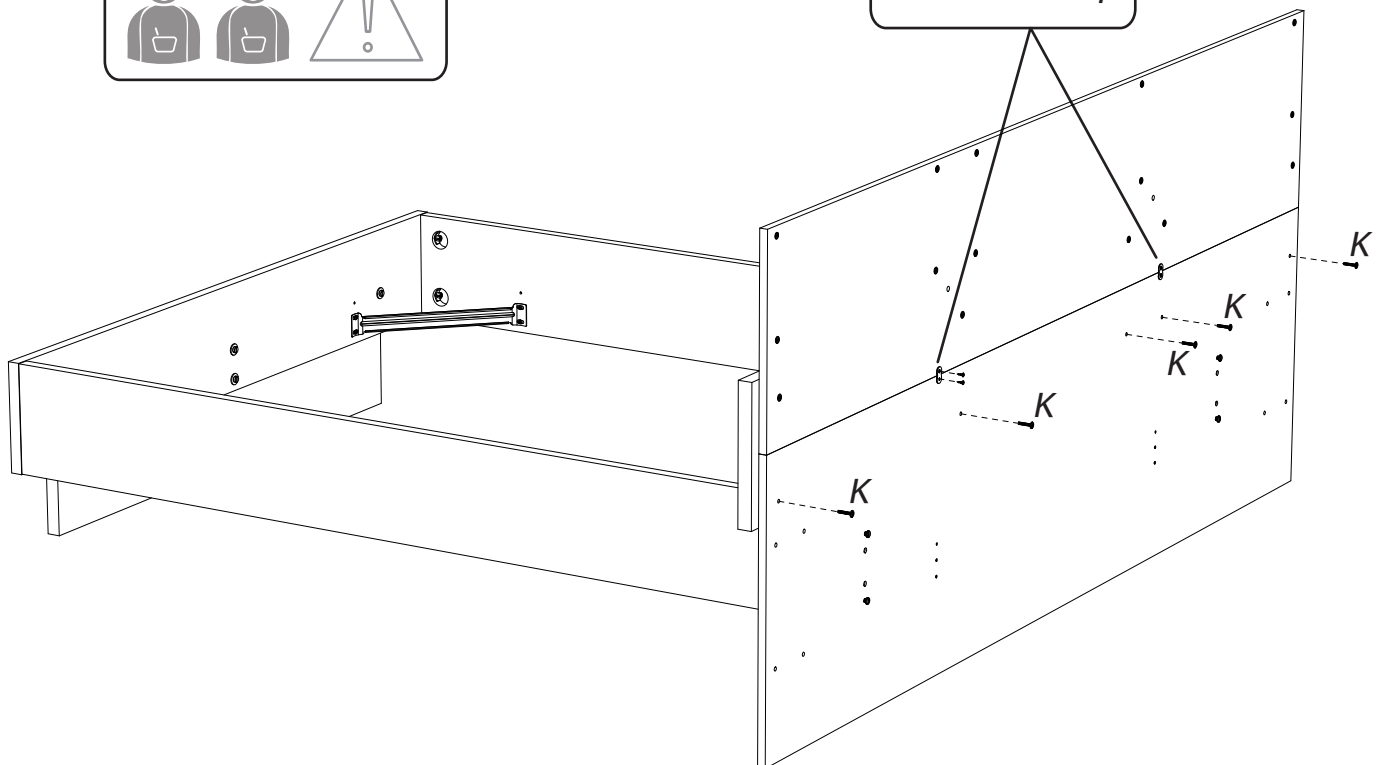
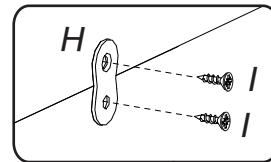
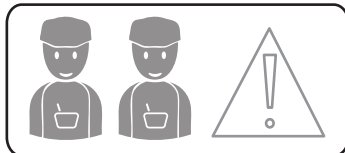
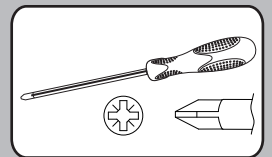
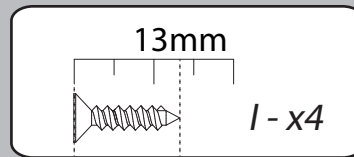
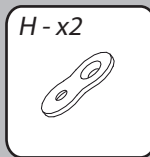
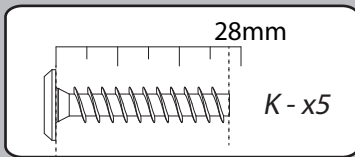

9

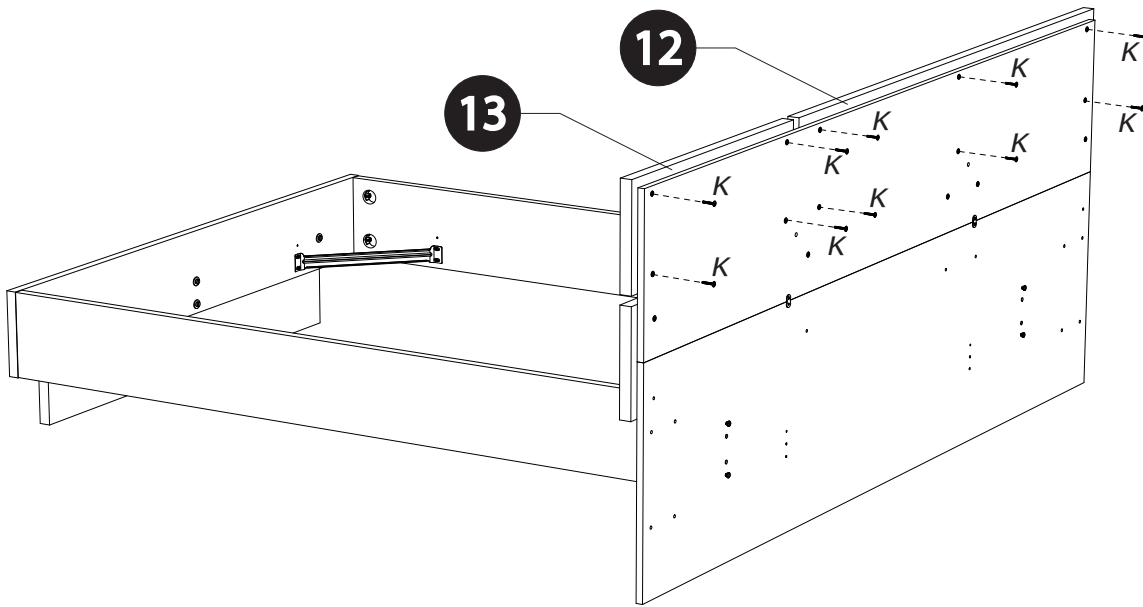
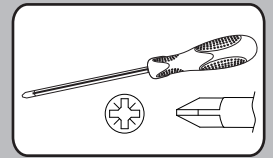
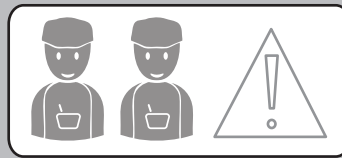
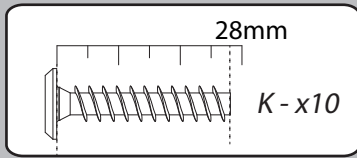

10

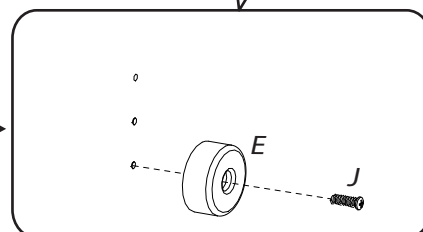
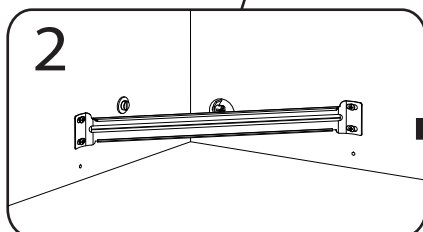
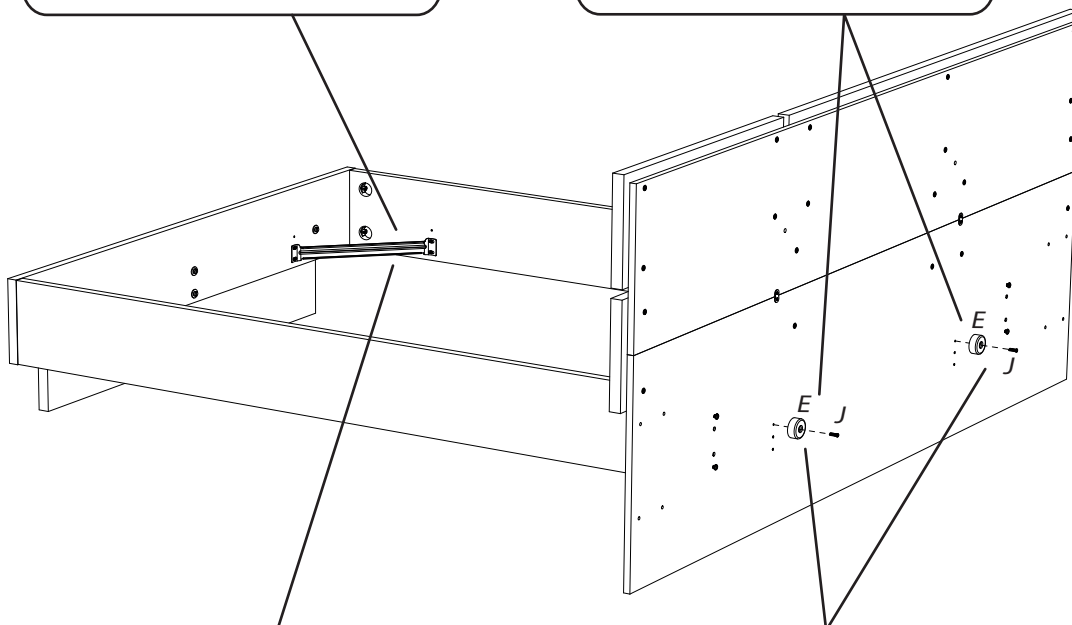
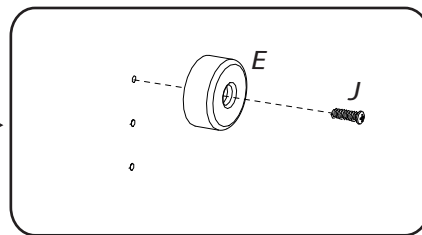
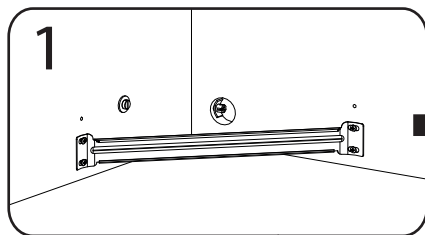
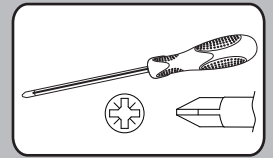
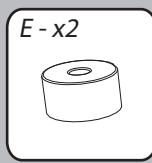
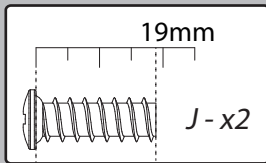

PRADO LIT 140 N°18 /

11

PRADO LIT 160 N°19 / PRADO LIT 180 N°20

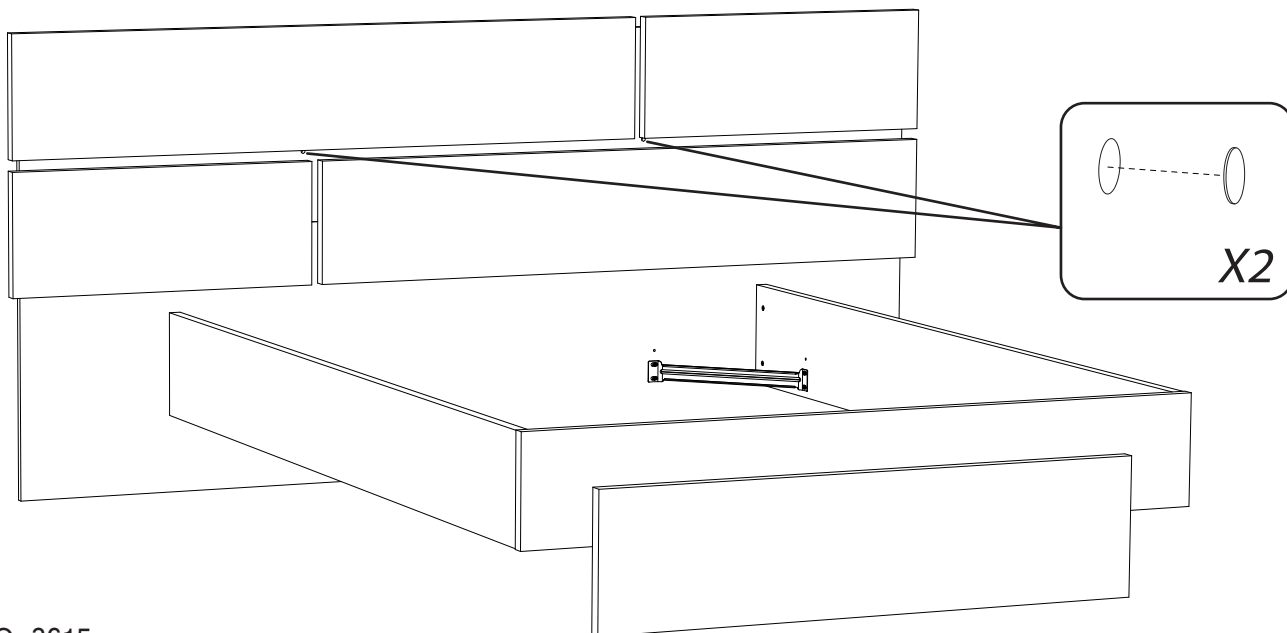
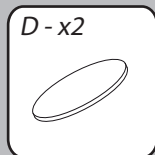
**PRADO 3615:**

Lit composé de panneaux de particules revêtus papier blanc (laqués blanc brillant pour le pied et les pans de lit) et revêtus papier noir (laqués Gris moonstone brillant pour l'habillage de pieds et les habillages de tête).

Lit 140 x 190 : L.220 cm - H.102,5 / 40 cm - P.198 cm.

Lit 160 x 200 : L.220 cm - H.102,5 / 40 cm - P.208 cm.

Lit 180 x 200 : L.220 cm - H.102,5 / 40 cm - P.208 cm.

A monter soi-même.

PRADO 4381:

Lit composé de panneaux de particules revêtus papier décor Oak endgrain et papier blanc (laqués blanc mat pour l'habillage de pied).

Lit 140 x 190 : L.220 cm - H.102,5 / 40 cm - P.198 cm.

Lit 160 x 200 : L.220 cm - H.102,5 / 40 cm - P.208 cm.

Lit 180 x 200 : L.220 cm - H.102,5 / 40 cm - P.208 cm.

A monter soi-même.

FRANCAIS**Recommandations de démontage :**

En cas de déménagement, il convient de procéder au démontage de votre meuble, en ôtant toute la visserie.

ENGLISH**Disassembly advices:**

In case of moving, it is needed to dismantle the furniture removing the fittings.

DEUTSCH**Empfehlungen für die Demontage:**

Bei Transport bitte alle Beschläge demontieren.

"Les meubles contenant des panneaux à base de bois (panneaux de particules, panneaux de fibres, contreplaqué...) peuvent émettre des substances polluantes dans l'air intérieur. Il est ainsi recommandé, après l'installation du meuble dans son logement, d'aérer fréquemment la pièce concernée pendant au moins quatre semaines afin de réduire son exposition aux polluants émis par le meuble."