

# ASSEMBLING INSTRUCTION

## DT-1003

step1

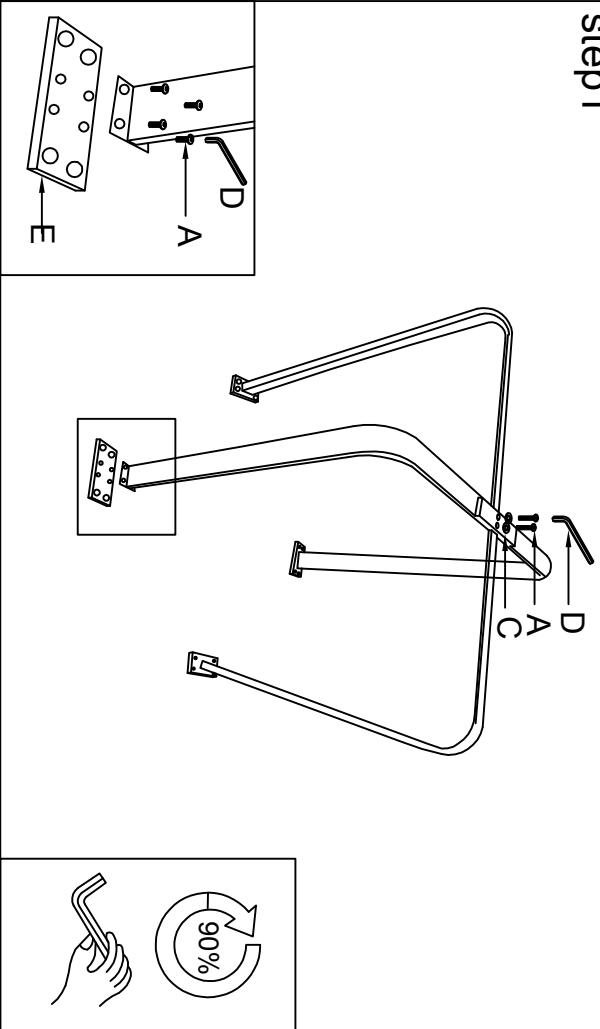

step2

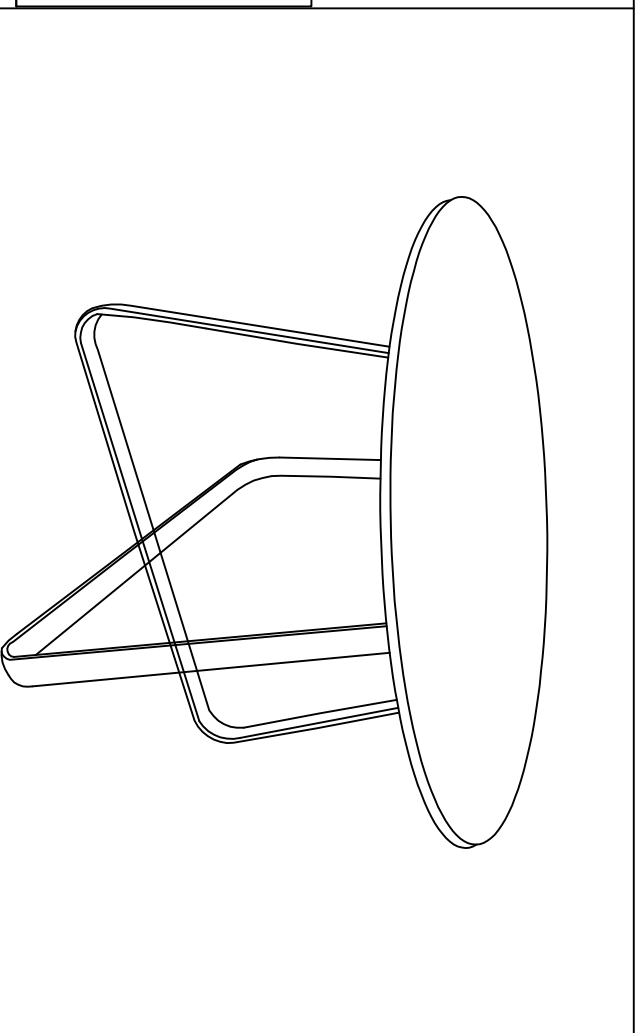
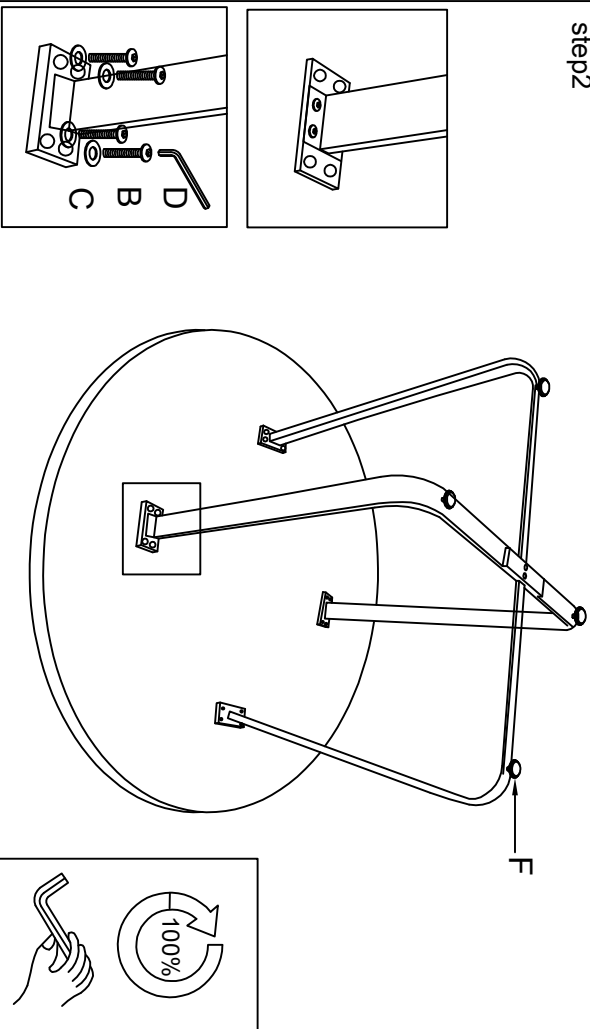

A.X18

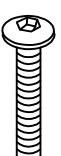

6x10mm

B.X16

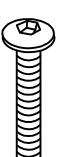

8x18mm

C.X18



D.X1

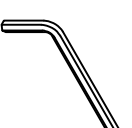

E.X4

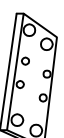

F.X4

