



44 Avenue Paul Girard
10500 DIENVILLE
FRANCE
www.sciae.com

AVEIRO

INDICE A - 09/05/2022

AVEIRO 0836 LIT 140 N°18 Réf: 22CC0314
AVEIRO 0838 LIT 140 N°18 Réf: 22CB0314

AVEIRO 0836 LIT 160 N°19 Réf: 22CC0316
AVEIRO 0838 LIT 160 N°19 Réf: 22CB0316

AVEIRO 0836 EAN: 3102000112718

AVEIRO 0836 EAN: 3102000112725

AVEIRO 0838 EAN: 3102000112640

AVEIRO 0838 EAN: 3102000112657

NOTICE DE MONTAGE
ASSEMBLING INSTRUCTIONS
MONTAGEANLEIUNG
MANUAL DE MONTAJE
MONTAGEVOORSCHRIFT
INSTRUÇÕES DE MONTAGEM
ISTRUZIONI DI MONTAGGIO
ИНСТРУКЦИЯ ПО СБОРКЕ
Naputci za montažu

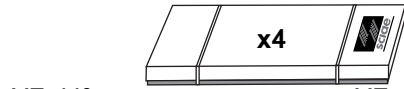
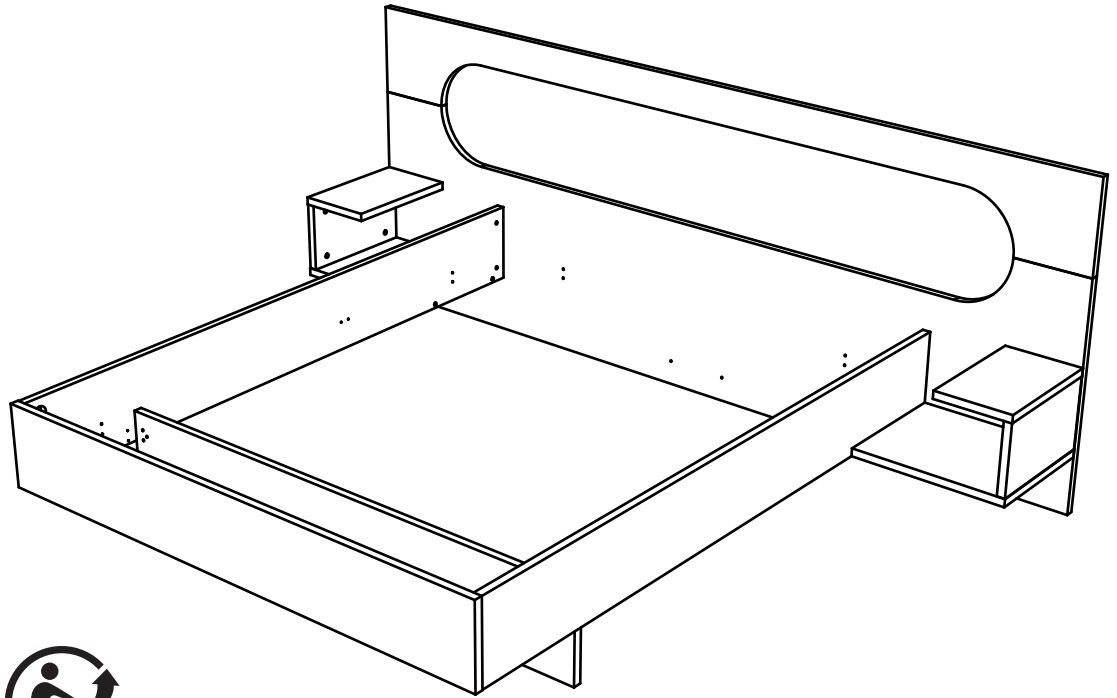

LIT 140
Package 1: 15 Kg
Package 2: 34 Kg
Package 3: 28.5 Kg
Package 4: 17 Kg

LIT 160
Package 1: 15 Kg
Package 2: 37 Kg
Package 3: 35.5 Kg
Package 4: 17.5 Kg

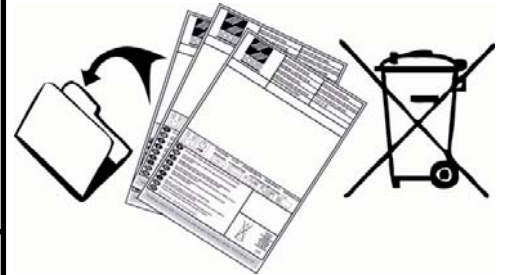

F POUR L'APRES-VENTE, RETOURNEZ AU MAGASIN AVEC CETTE NOTICE

GB FOR THE AFTER SALES, GO BACK TO THE SHOP WITH THIS ASSEMBLY INSTRUCTION

D WENDEN SIE SICH BITTE AN IHREN HANDLER UND GEBEN SIE IHM DIE KENNUMMER DES MOBELS UND DIE TEILNUMMER

E EN CASO DE SERVICIO POST-VENTA DEBEN DE VOLVER A LA TIENDA CON LAS INSTRUCCIONES DE MONTAJE

NL VOOR SERVICE NA VERKOOP, GA NAAR UW LEVERANCIER MET DEZE MONTAGE HANDLEIDING

P PARA O POS VENDA, VOLTE A LOJA COM ESTA FOLHA

I SERVIZIO POST VENDITA: E NECESSARIO PRESENTARSI SUL PUNTO VENDITA CON QUESTE ISTRUZIONI DI MONTAGGIO

RU ДЛЯ ПОСЛЕПРОДАЖНОГО ОБСЛУЖИВАНИЯ ПРОСЬБА ОБРАТИТЬСЯ В МАГАЗИН ПРЕДЪЯВИВ НАСТОЯЩУЮ ИНСТРУКЦИЮ ПО СБОРКЕ

HR U SLUČAJU REKLAMACIJE, VRATITE SE NA PRODAJNO MJESTO S OVIM UPUTAMA ZA MONTAŽU

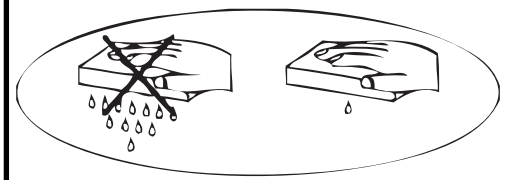

	+40°C +104°F	
	HYGROMETRIE HYGROMETRY 40%-65%	
	+15°C +59°F	

1 an
1 year

OK

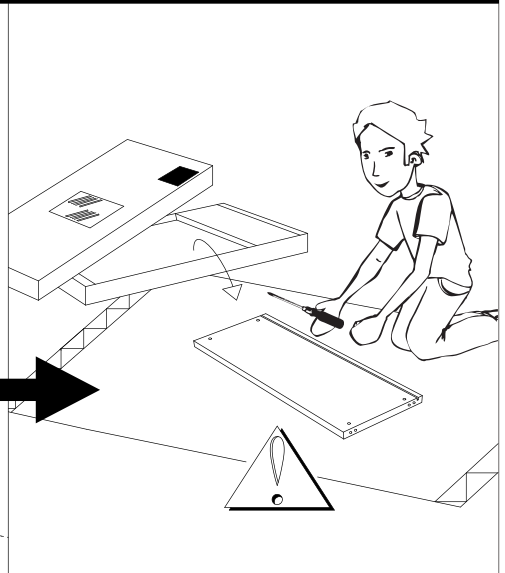
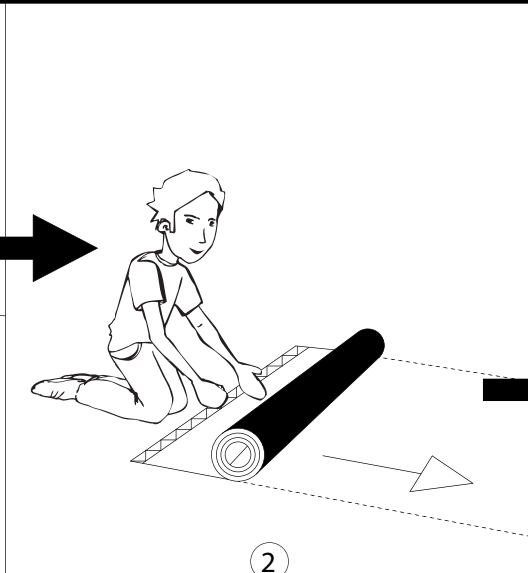
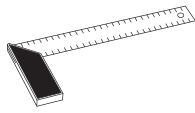
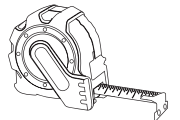
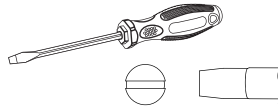
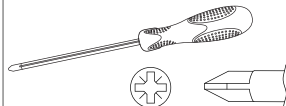
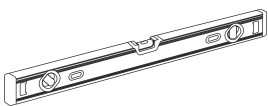
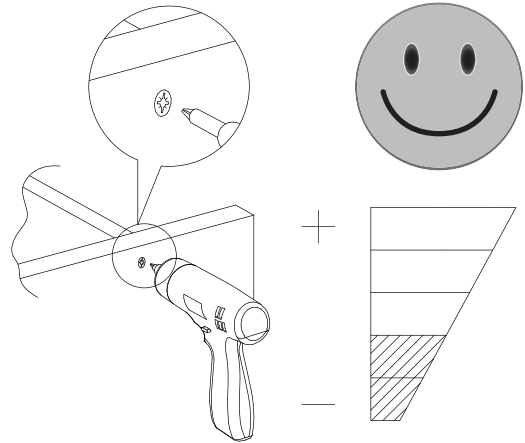
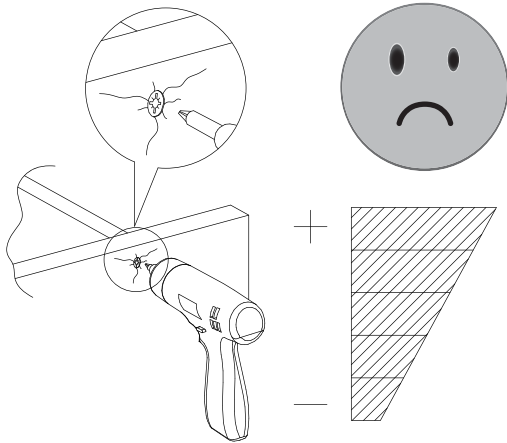
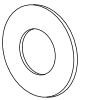
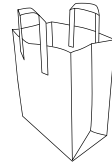
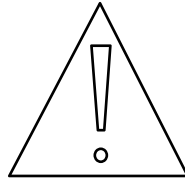

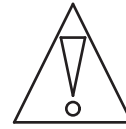
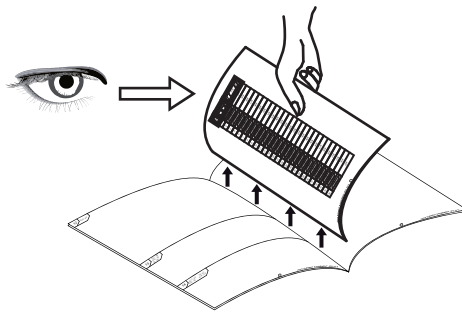

1

A - x4

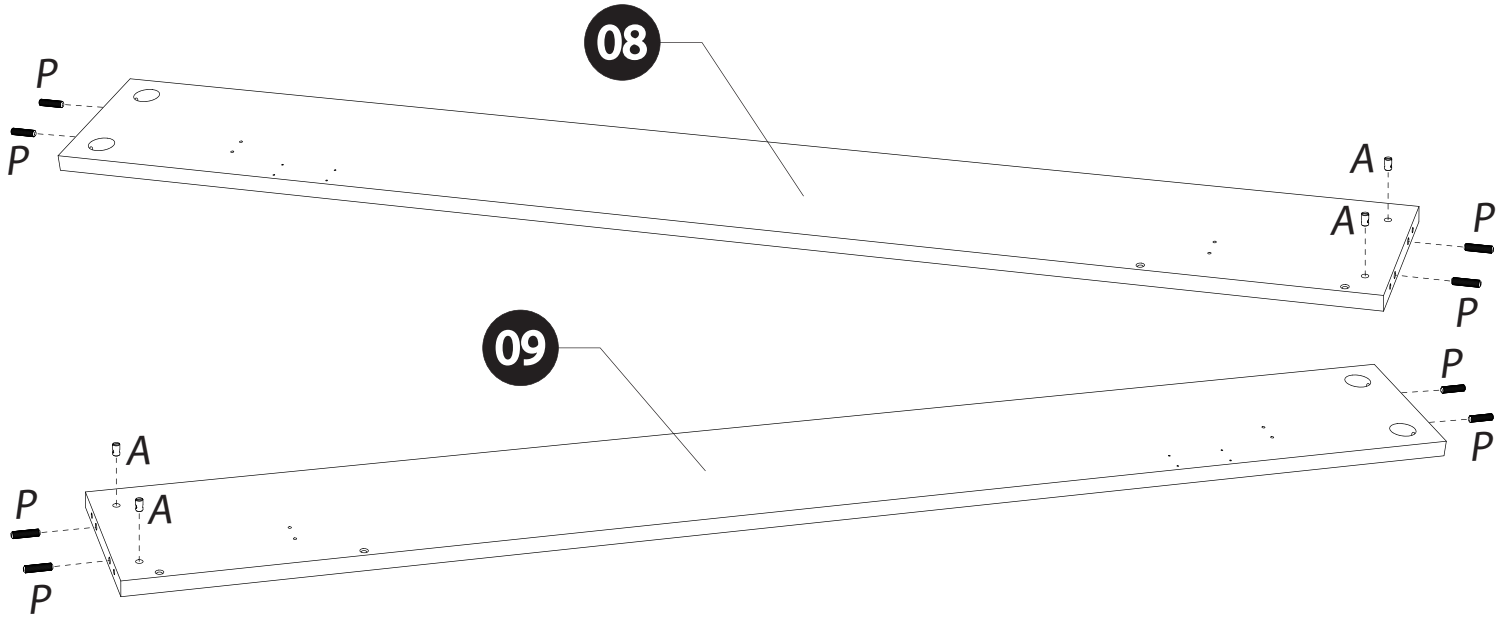
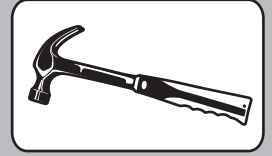
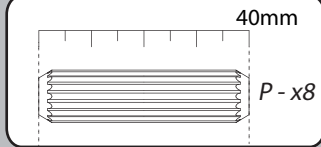

2

B+W

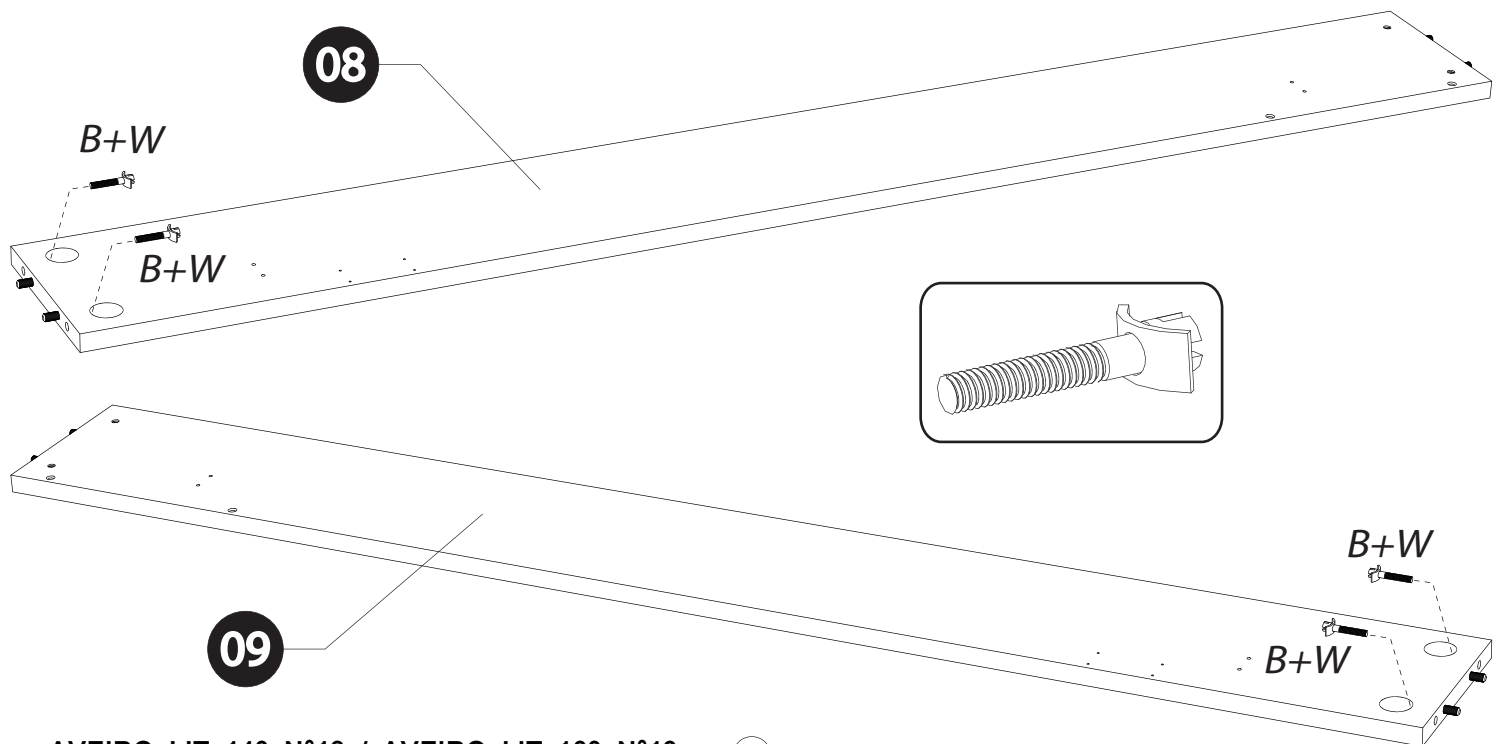
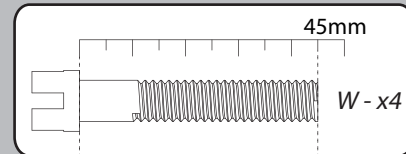

3

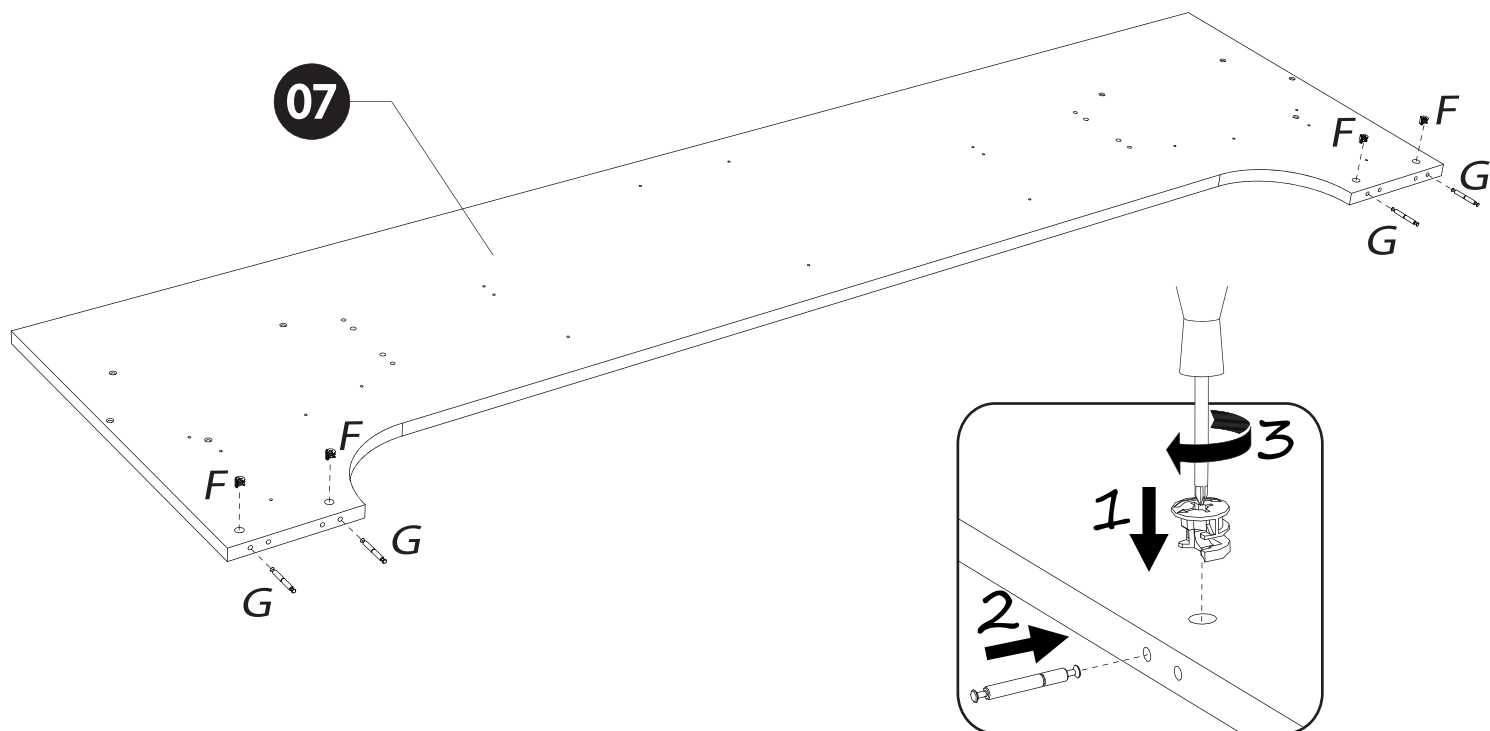
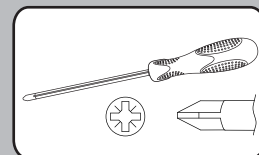
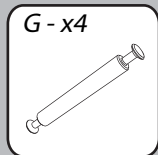
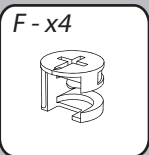

4

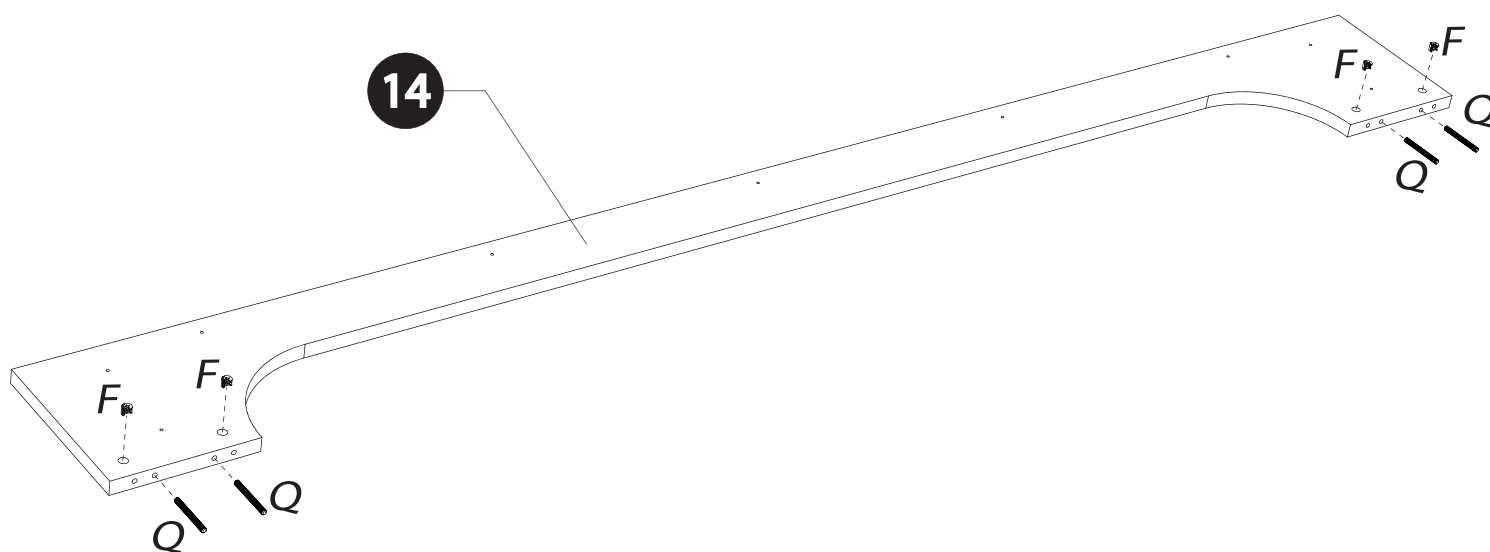
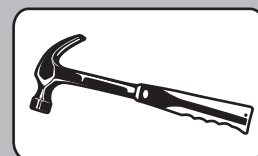
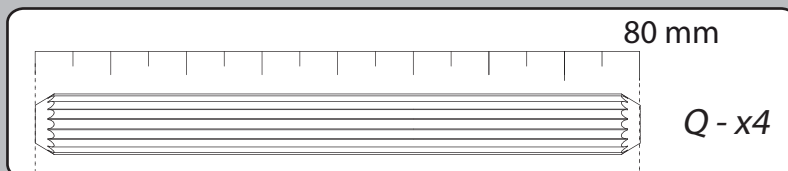
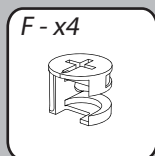

5

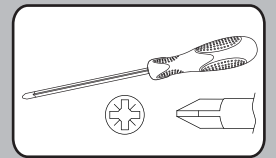
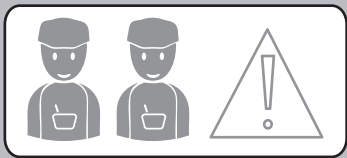

14

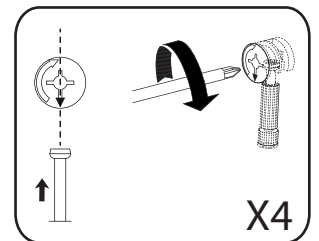
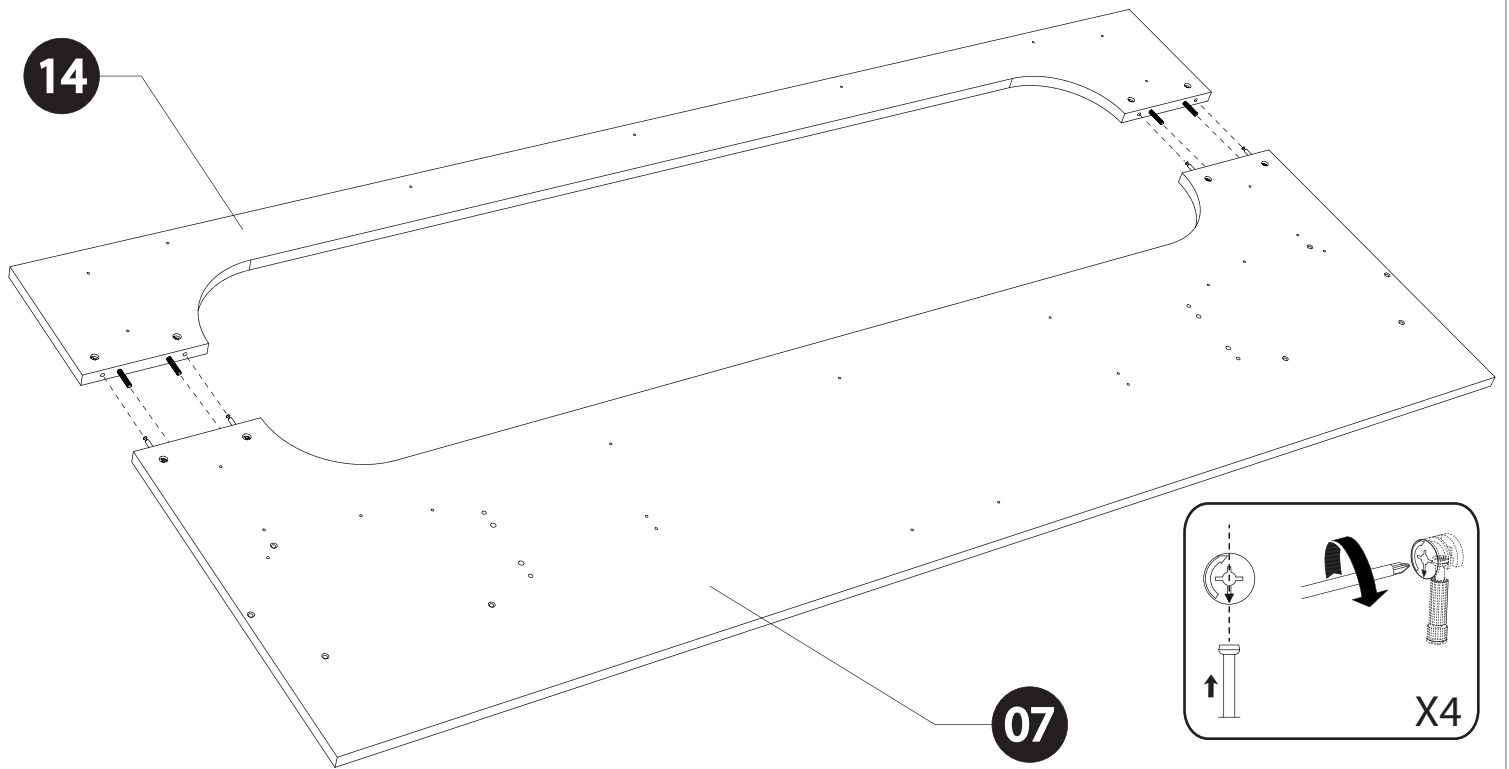

6

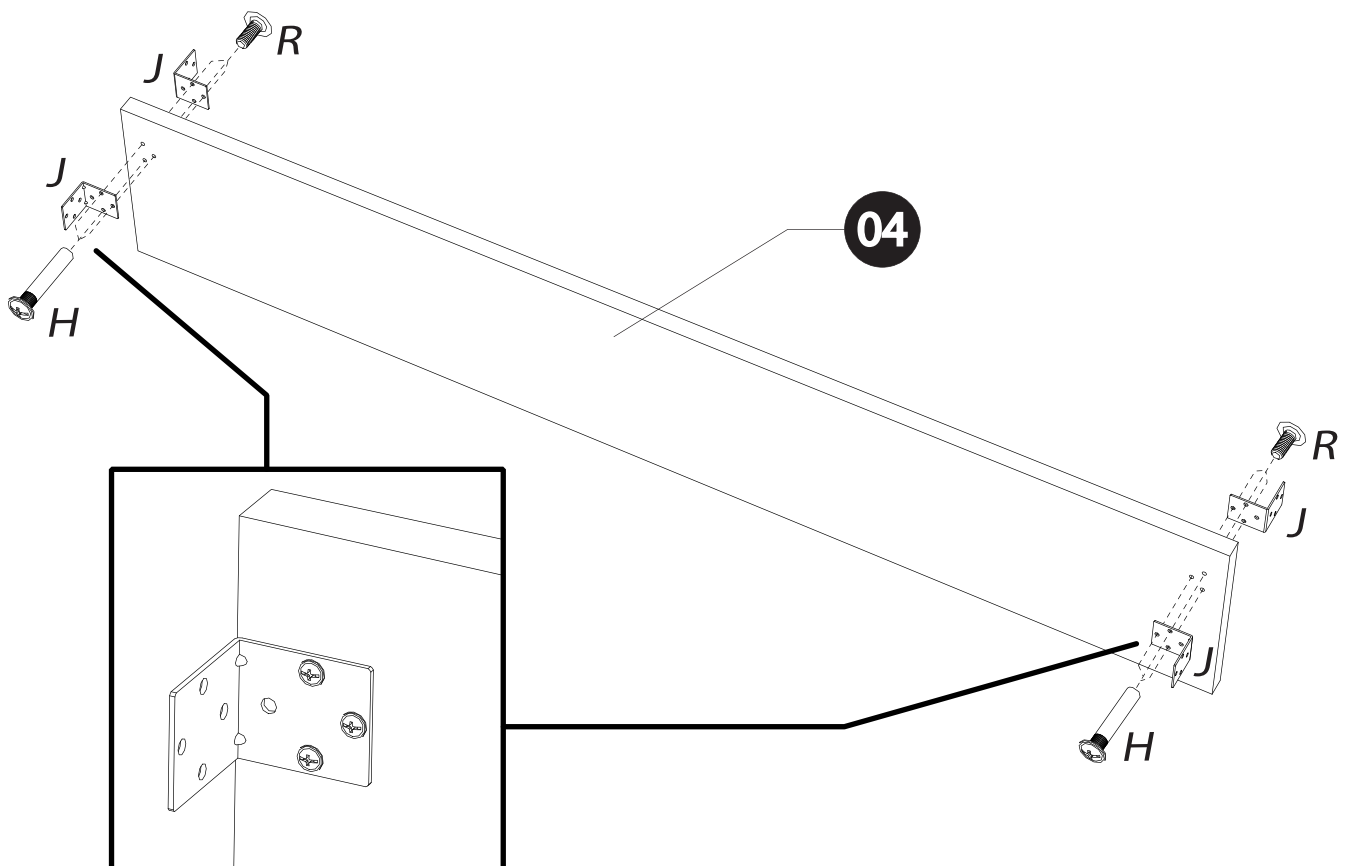
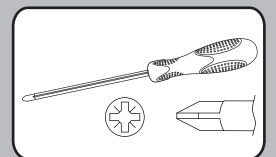
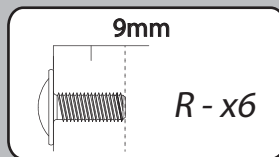
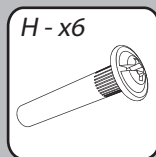
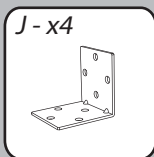

7

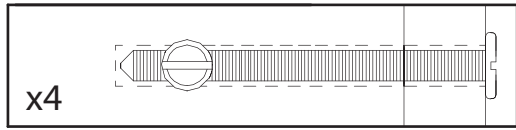
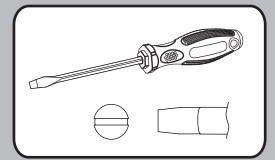
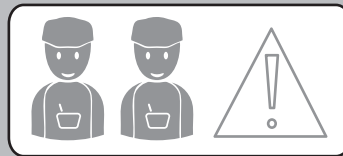
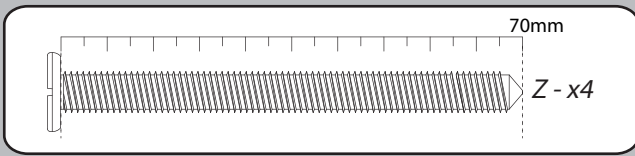

08

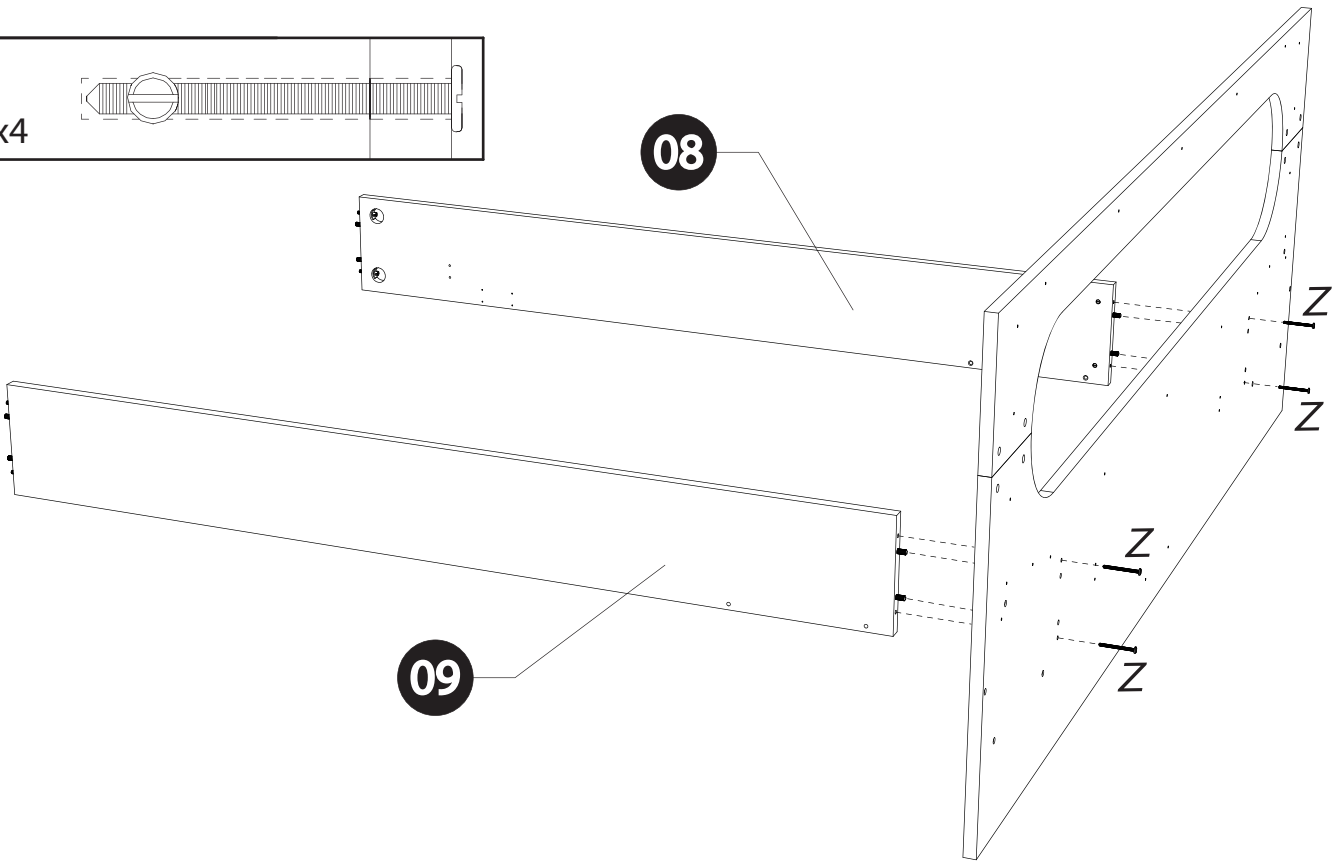

8

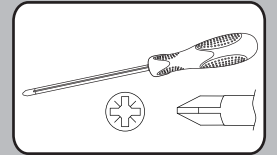
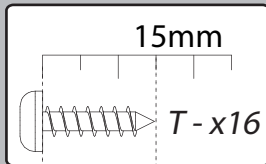

x4

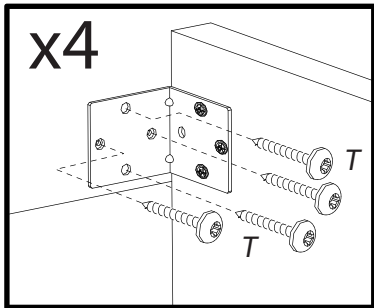

04

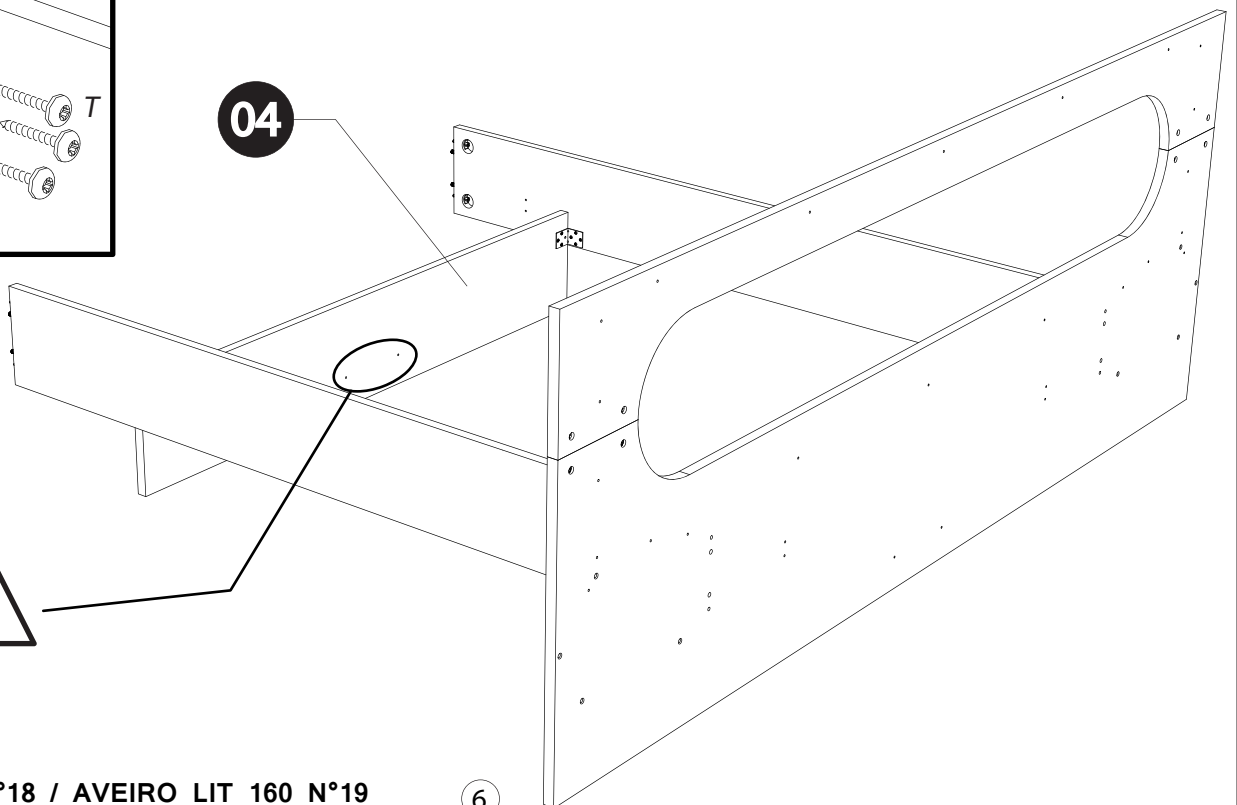

9

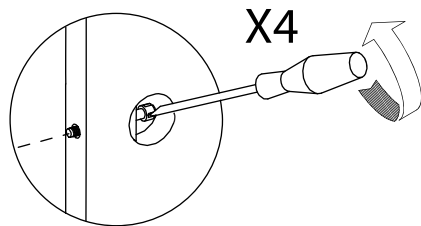
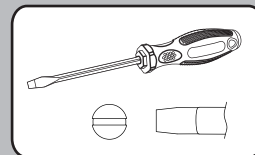
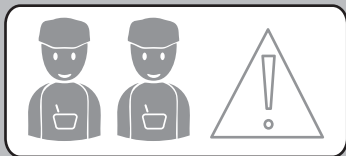

04

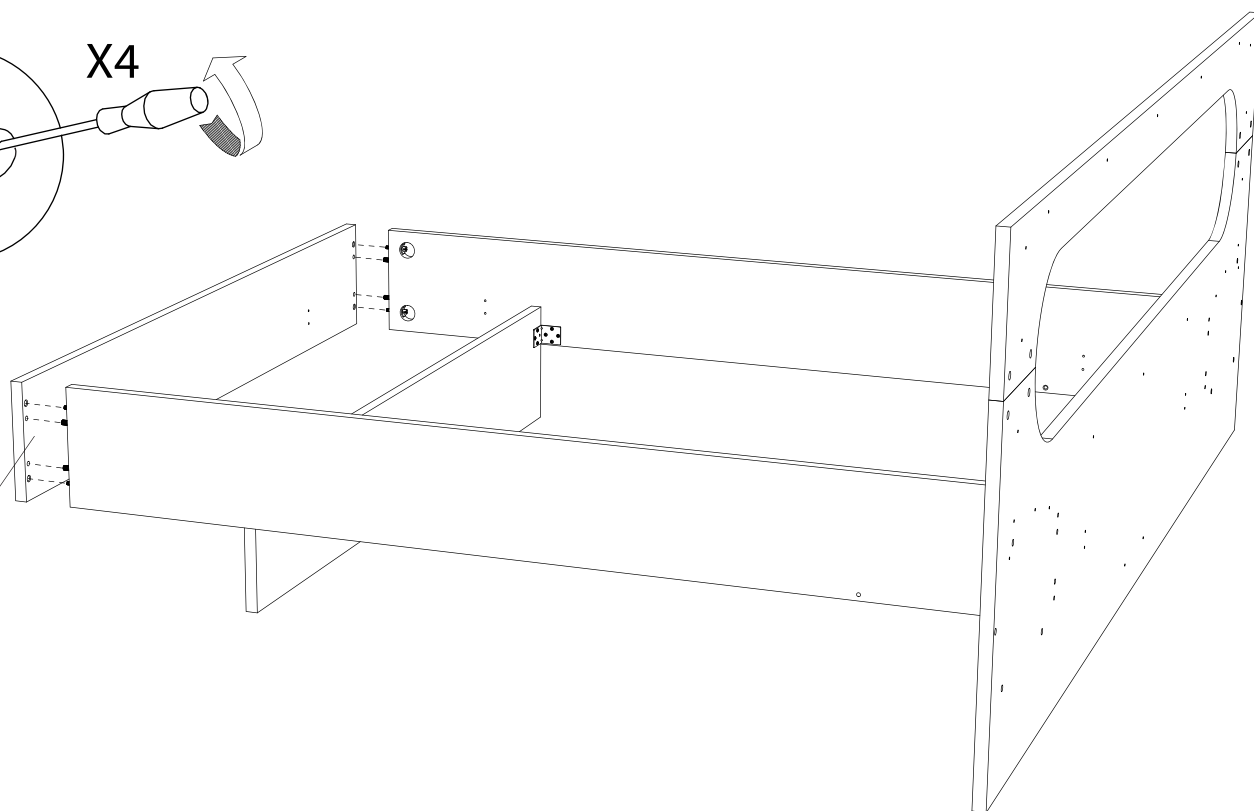

10

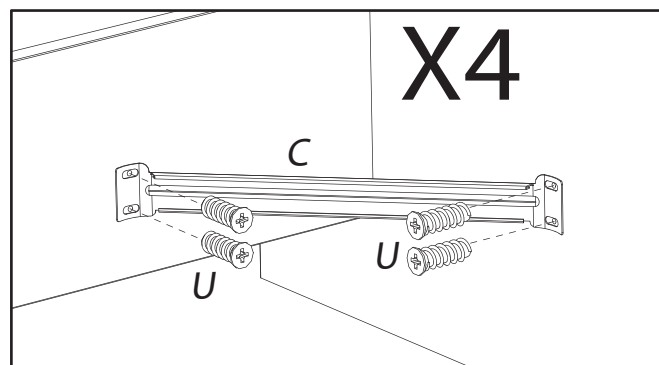
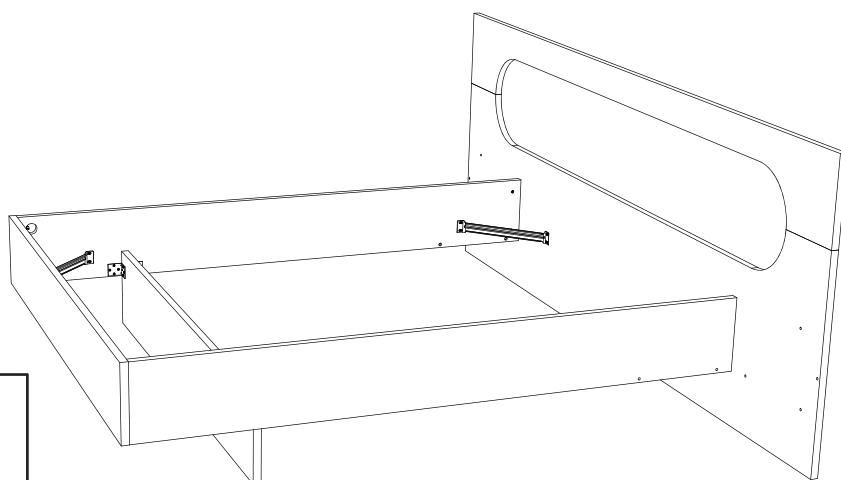
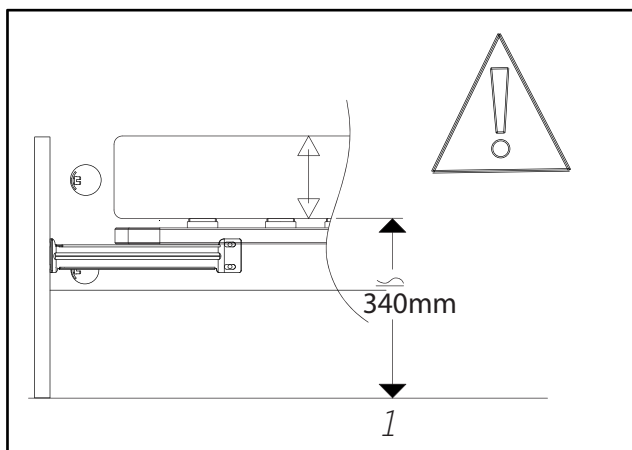
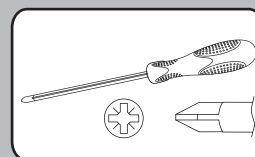
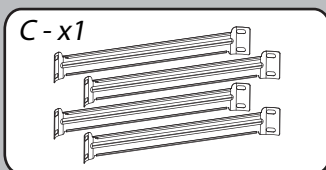
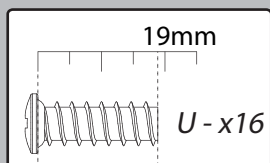

7

11

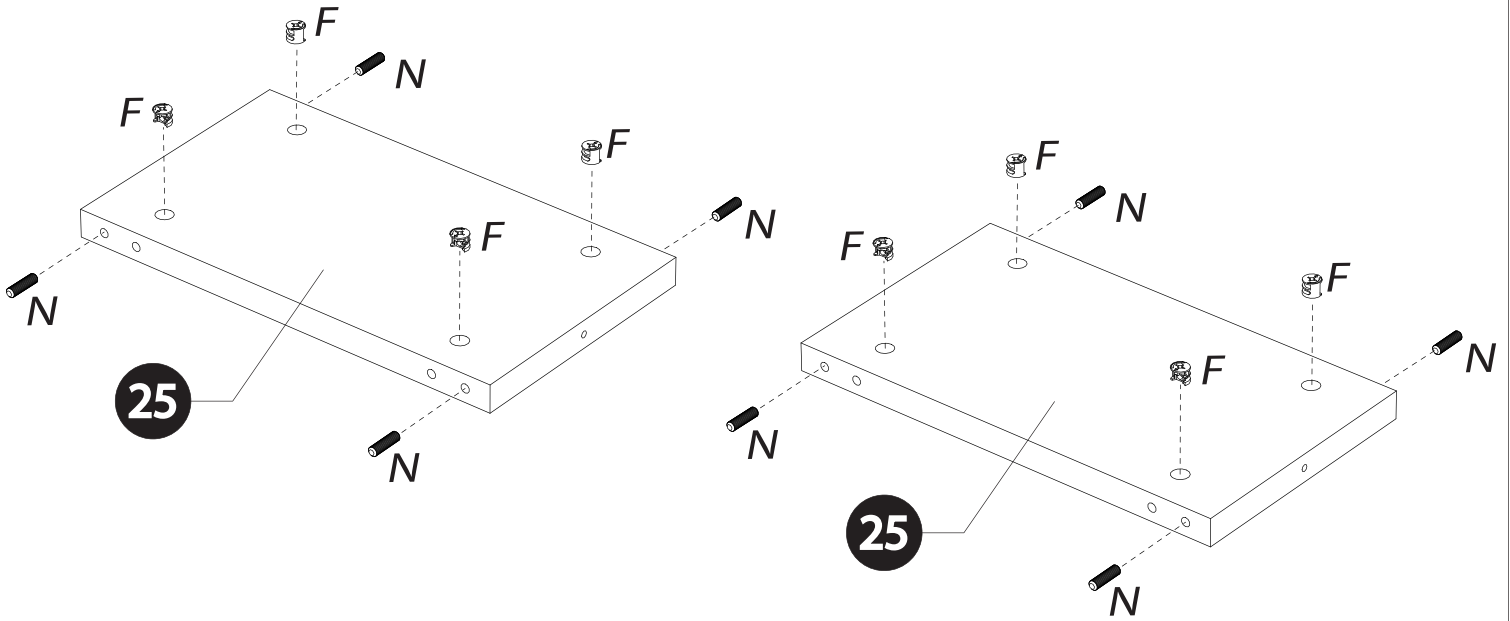
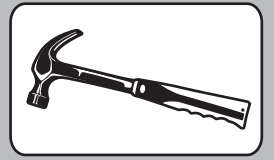
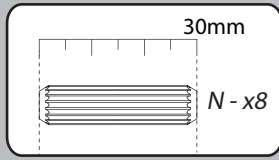
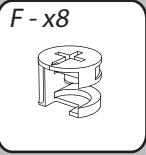



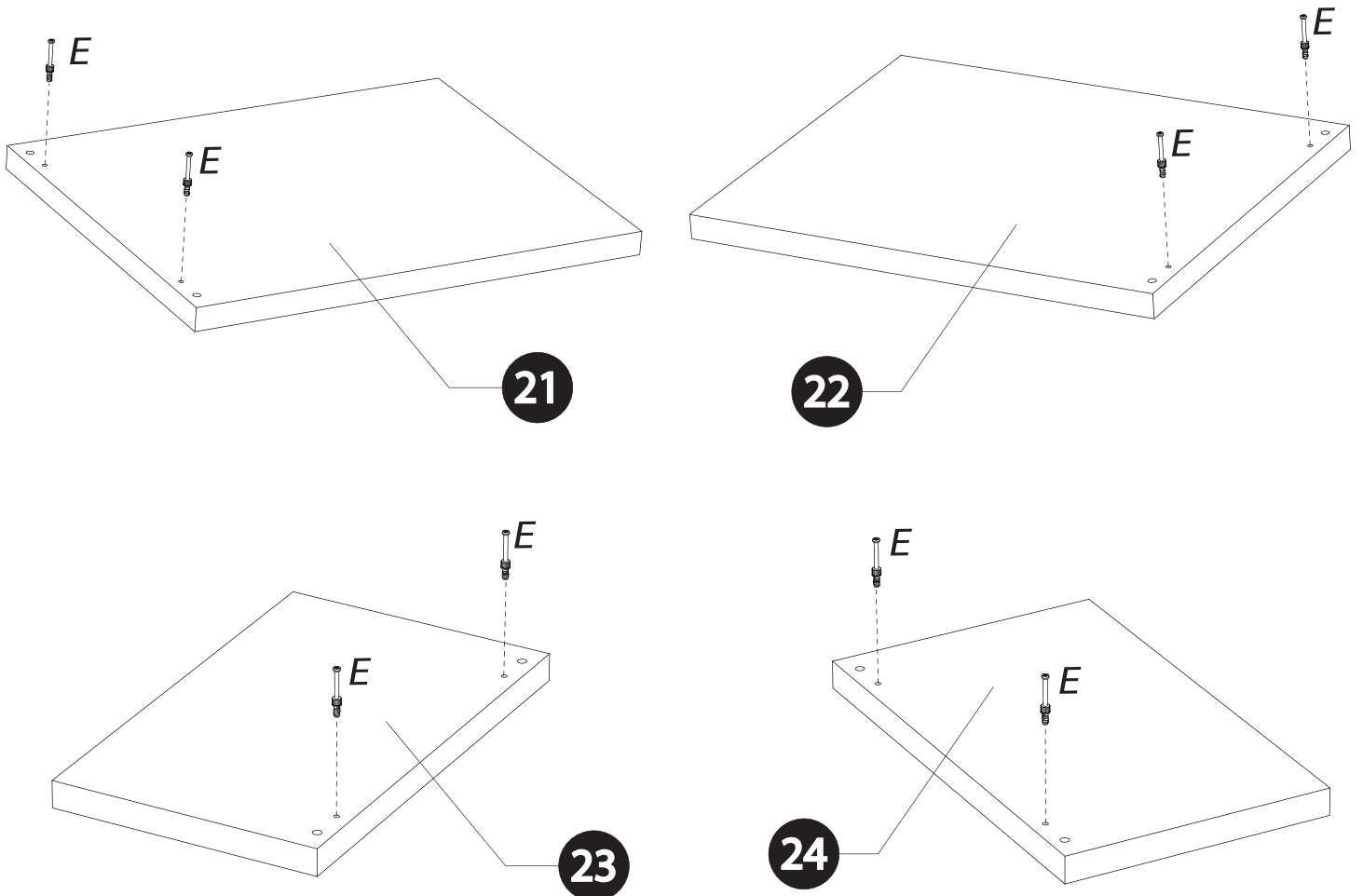
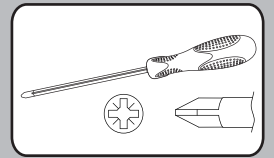
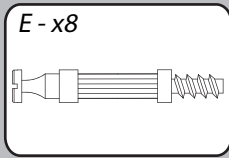

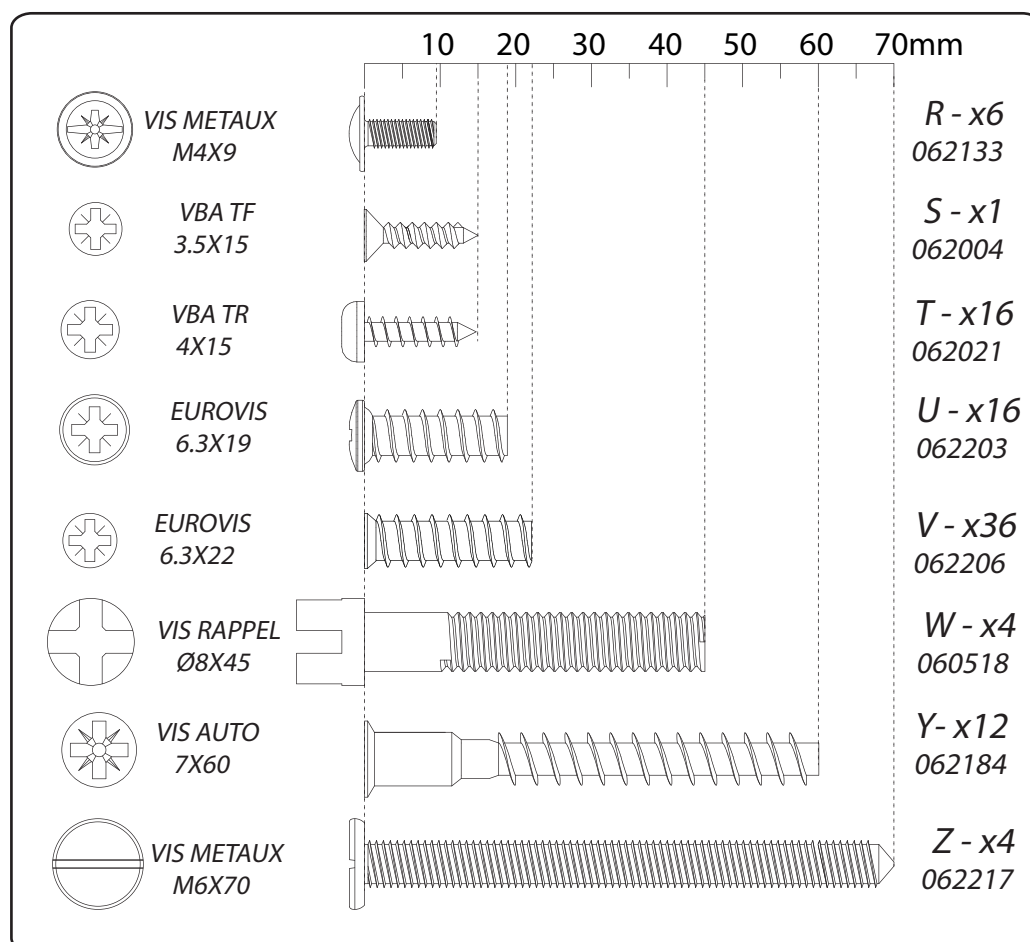
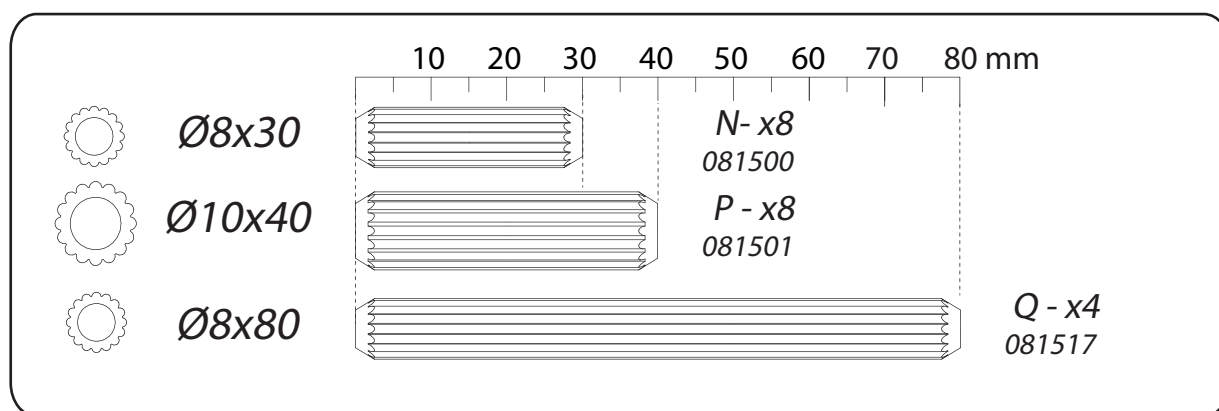
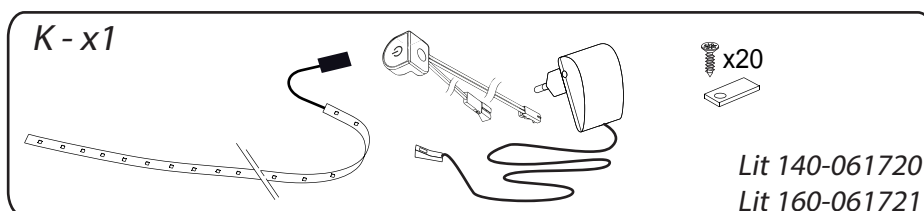
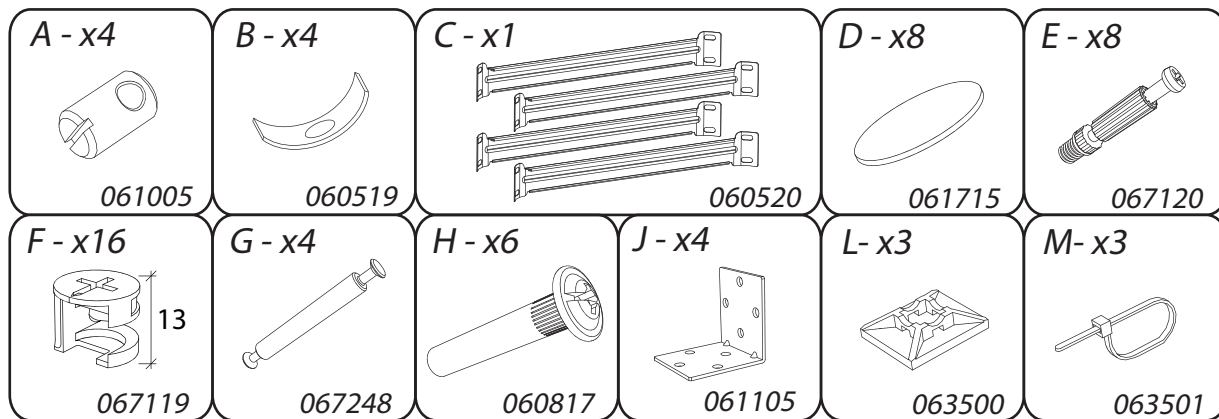



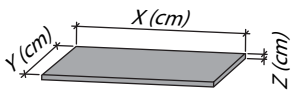
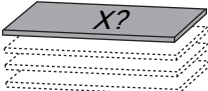
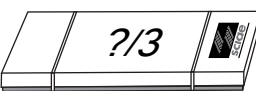

12





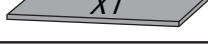
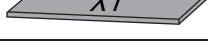
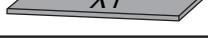
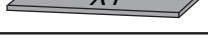





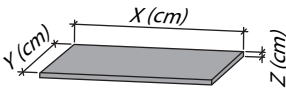
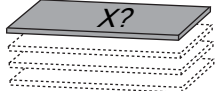
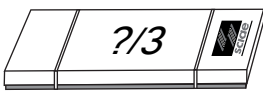

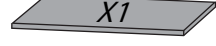

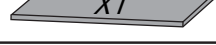
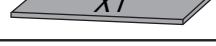
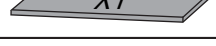

LIT 140 N°18

<i>DESIGNATION</i>		<i>N°</i>		
Pied de lit	146.2 x 25.4 x 2.5	1		3
Pied intérieur	141 x 28 x 2.5	4		3
Tête de lit basse	244 x 73.4 x 2.5	7		2
Traverse support px décor	205 x 5.5 x 1.6	10		3
Montant support px décor	56.1 x 11 x 1.6	11		3
Panneau décor tête de lit	216 x 56 x 1.2	13		3
Tête de lit haute	244 x 29.6 x 2.5	14		2
Dessous chevet gauche	49 x 40 x 2.5	21		1
Dessous chevet droit	49 x 40 x 2.5	22		1
Dessus chevet gauche	24.5 x 40 x 2.5	23		1
Dessus chevet droit	24.5 x 40 x 2.5	24		1
Côté de chevet	22.8 x 39.9 x 2.5	25		1

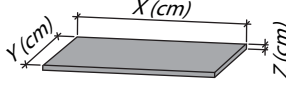
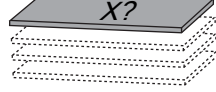
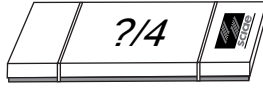

LIT 160 N°19

<i>DESIGNATION</i>		<i>N°</i>		
Pied de lit	166.2 x 25.4 x 2.5	1		3
Pied intérieur	161 x 28 x 2.5	4		3
Tête de lit basse	264 x 73.4 x 2.5	7		2
Traverse support px décor	225 x 5.5 x 1.6	10		3
Montant support px décor	56.1 x 11 x 1.6	11		3
Panneau décor tête de lit	236 x 56 x 1.2	13		3
Tête de lit haute	264 x 29.6 x 2.5	14		2
Traverse support literie	159.6 x 11 x 3	17		3
Dessous chevet gauche	49 x 40 x 2.5	21		1
Dessous chevet droit	49 x 40 x 2.5	22		1
Dessus chevet gauche	24.5 x 40 x 2.5	23		1
Dessus chevet droit	24.5 x 40 x 2.5	24		1
Côté de chevet	22.8 x 39.9 x 2.5	25		1

PANS 190

<i>DESIGNATION</i>		<i>N°</i>		
Pan gauche	191 x 25.3 x 2.5	8		4
Pan droit	191 x 25.3 x 2.5	9		4

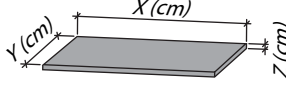
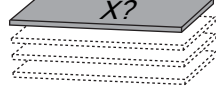
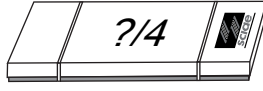
PANS 200

<i>DESIGNATION</i>		<i>N°</i>		
Pan gauche	201 x 25.3 x 2.5	8		4
Pan droit	201 x 25.3 x 2.5	9		4

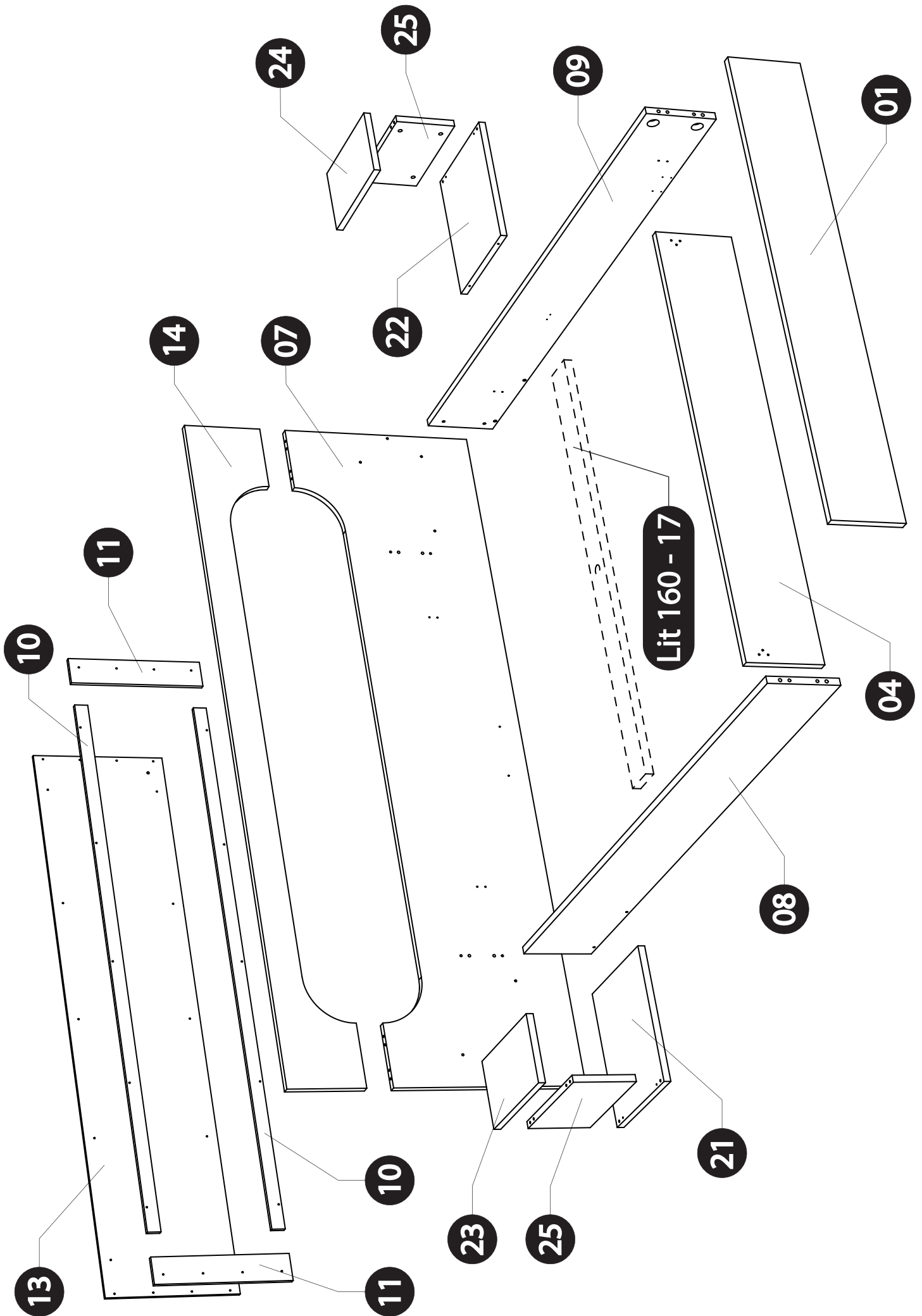

13

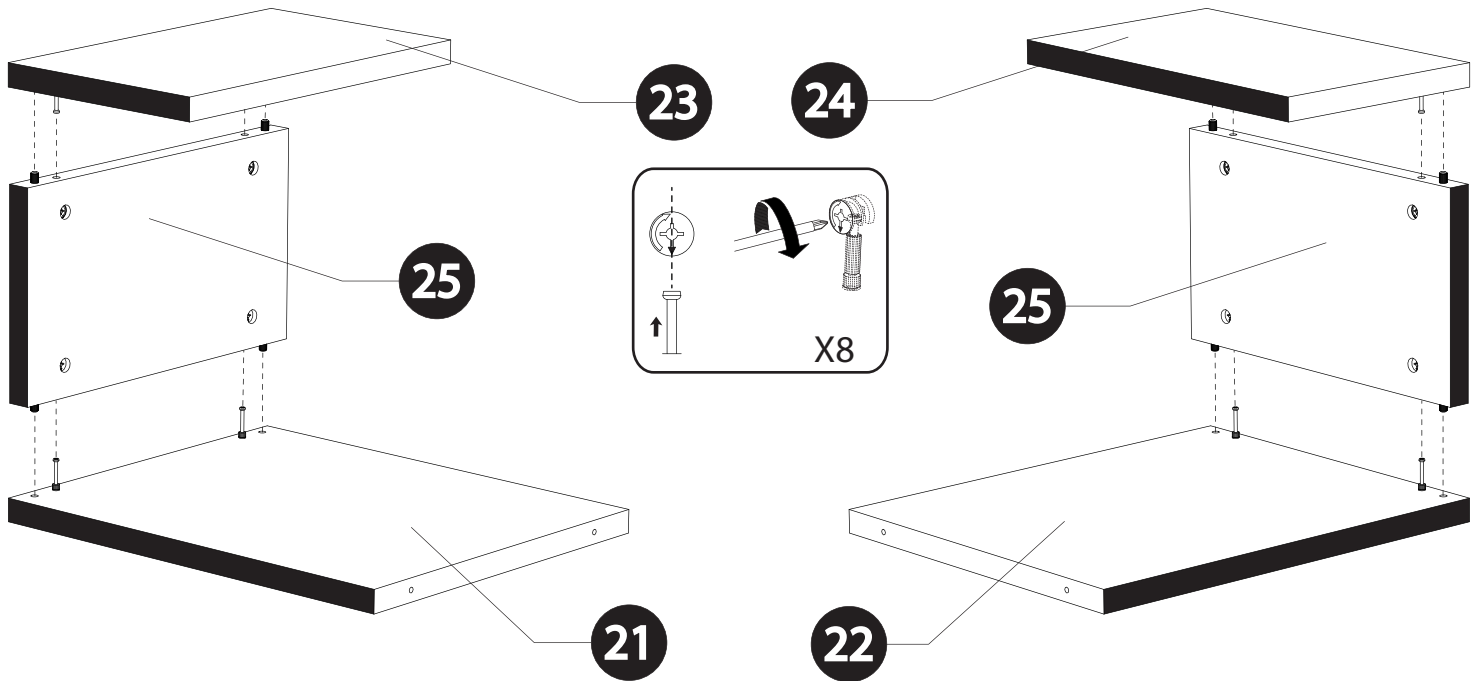
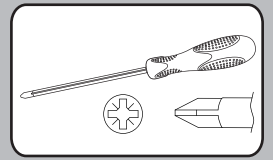

14

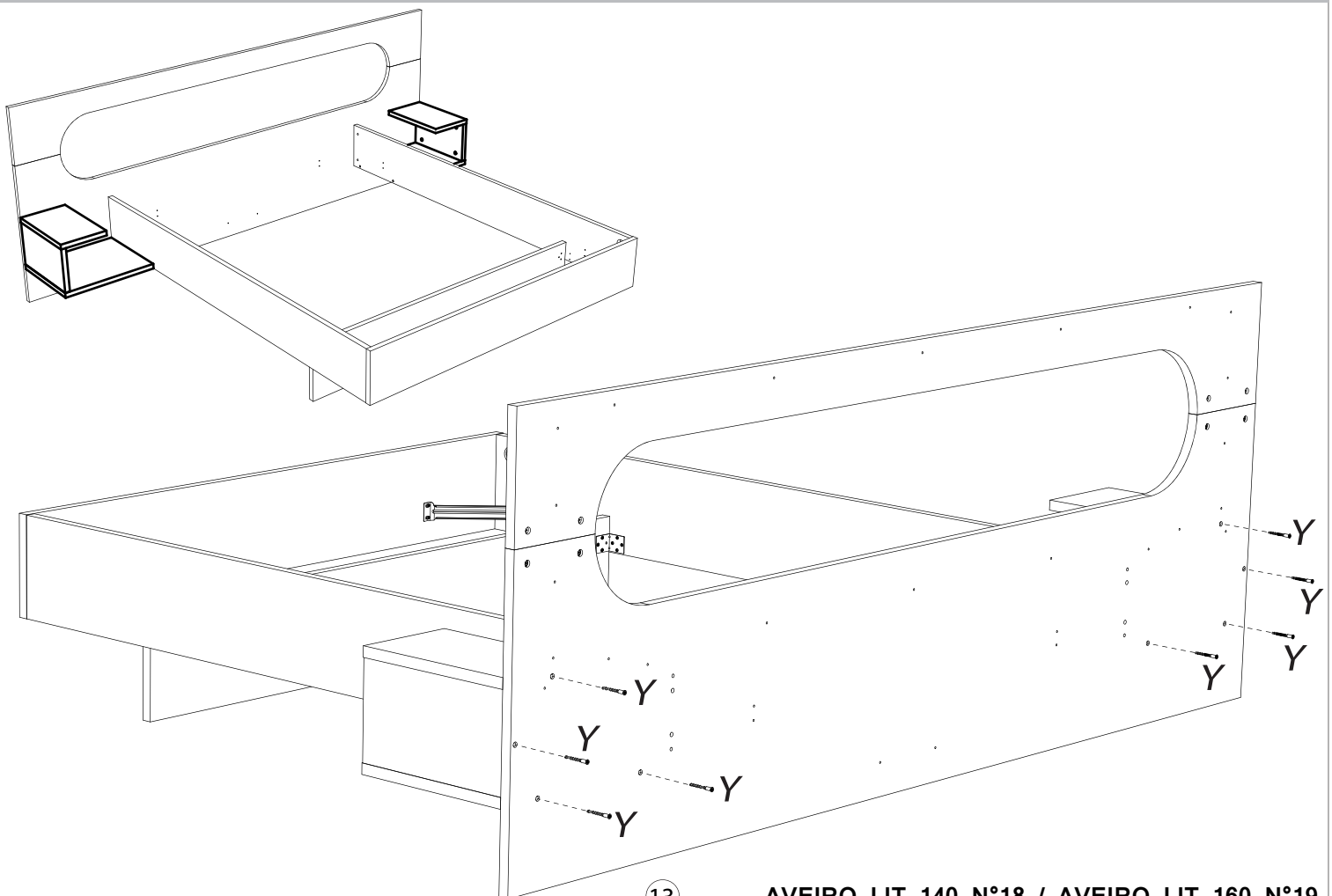
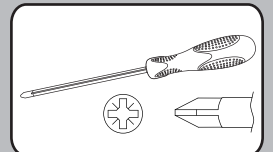
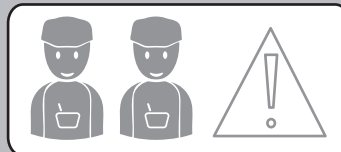
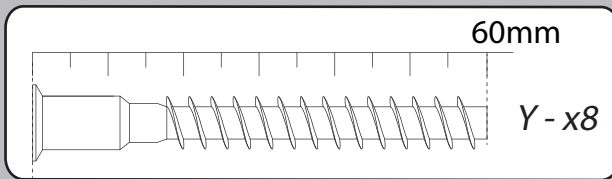

13

AVEIRO LIT 140 N°18 / AVEIRO LIT 160 N°19

15

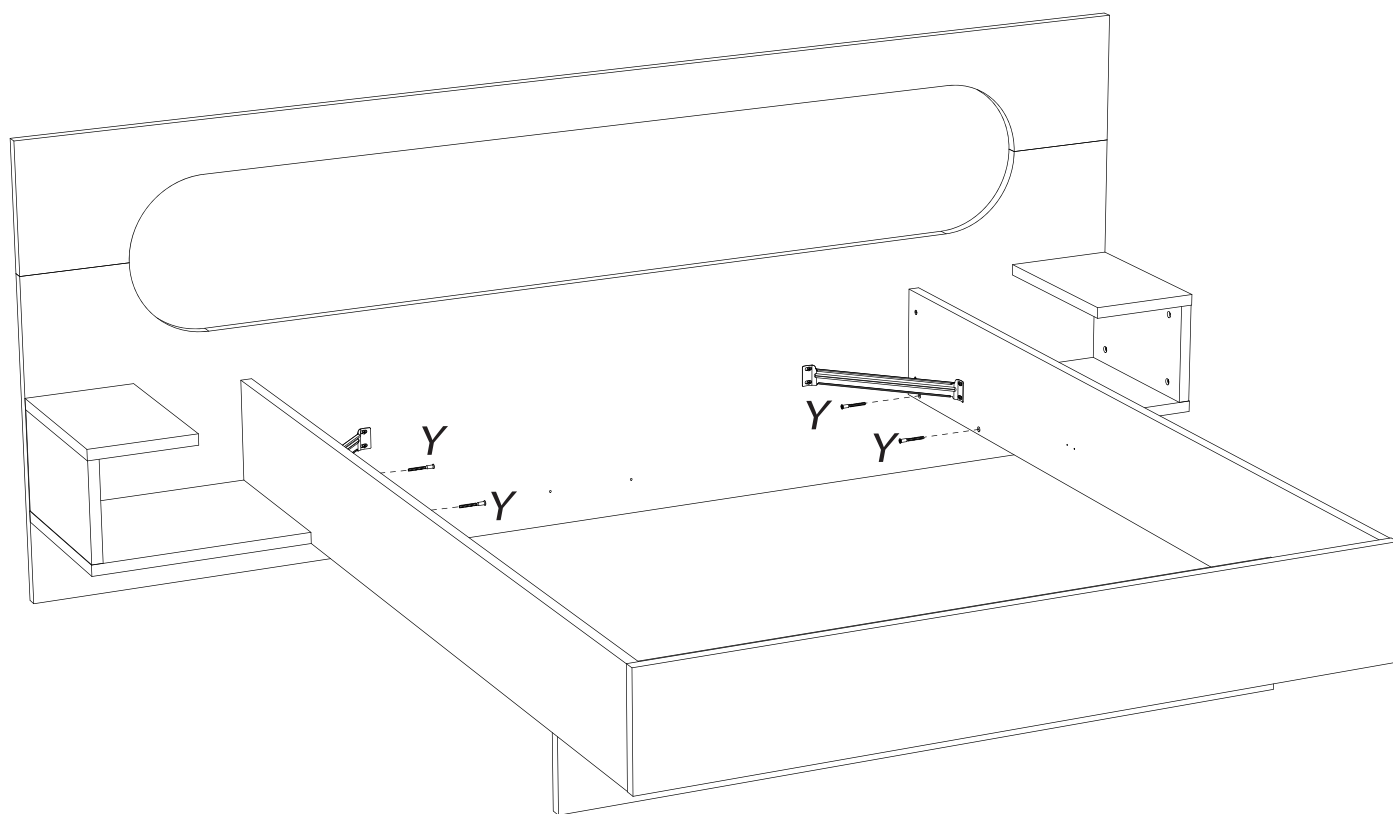
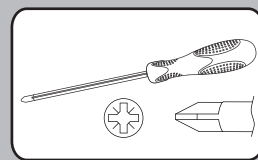
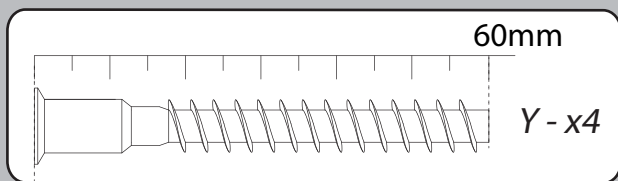

16

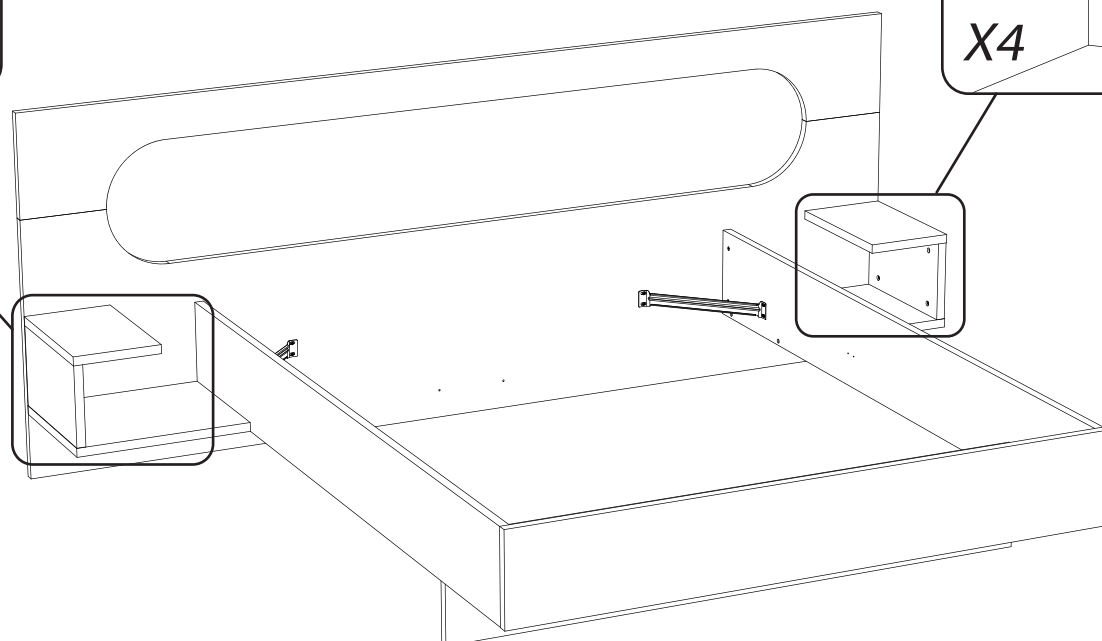
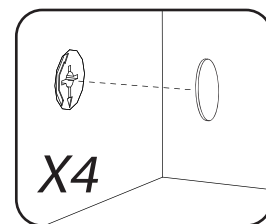
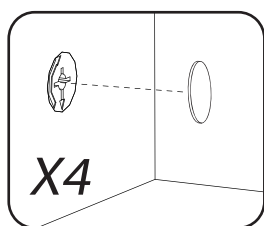
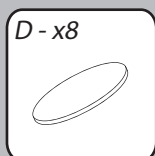



F

INSTRUCTION GÉNÉRALE DU LUMINAIRE

REMARQUES

SCIAE Dienville n'est pas responsable des dommages résultant :

- d'un mauvais montage
- de l'emploi d'outils inappropriés
- de changements techniques de l'ensemble
- du non-respect de cette instruction.

A LIRE AVANT DE PROCEDER AU MONTAGE

L'ensemble est conçu pour une tension d'alimentation de 230V ~ 50Hz, il est fait en 2e classe de protection et marqué par un symbole  approprié.

L'indice de protection de l'ensemble : IP20

Brancher l'ensemble à une prise de 230V ~ 50Hz en bon état de fonctionnement.

Le montage doit être effectué conformément à l'instruction.

ATTENTION !

Lors du montage, il faut strictement débrancher l'ensemble du courant 230V ~ 50Hz, respecter les règles de sécurité et rester particulièrement prudent.

La puissance électrique totale des montures de l'ensemble ne peut pas dépasser la puissance nominale du chargeur.

Les montures désignées par le symbole  doivent être installées sur une surface incombustible. Pour nettoyer, il faut utiliser uniquement un chiffon sec et ne jamais utiliser de produits chimiques.

MONTAGE

Effectuer le montage dans l'ordre conforme au mode d'emploi.

Il faut s'assurer que toutes les connexions électriques et les fixations soit effectuées correctement, de façon à exclure tout fonctionnement défectueux.

Lors du déplacement des meubles, veuillez particulièrement à ne pas endommager l'isolation des câbles électriques de l'ensemble.

EN

GENERAL LUMINAIRE INSTRUCTION

NOTES

SCIAE Dienville is not liable for any damage resulting from :

- a bad assembly
- the use of inappropriate tools
- of technical changes to the whole
- for non-compliance with this instruction.

TO BE READ BEFORE ASSEMBLY

The unit is designed for a supply voltage of 230V ~ 50Hz, it is made in 2nd protection class and marked with an appropriate symbol .

The protection index of the set : IP20

Connect the unit to a 230V ~ 50Hz socket in good working order.

Installation must be carried out in accordance with the instructions.

ATTENTION !

During installation, the entire 230V ~ 50Hz power supply must be strictly disconnected, respect the safety rules and remain particularly careful.

The total electrical power of the frames in the set may not exceed the charger's power rating.

Frames marked with the symbol  must be installed on a non-combustible surface. To clean, use only a dry cloth and never use chemicals.

ASSEMBLY

Carry out the assembly in the order described in the operating instructions.

Make sure that all electrical connections and fixings are carried out correctly, so that faulty operation is excluded.

When moving the furniture, be particularly careful not to damage the following when moving it the insulation of the electric cables of the whole.

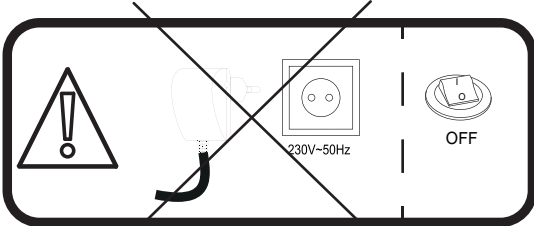
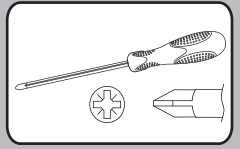
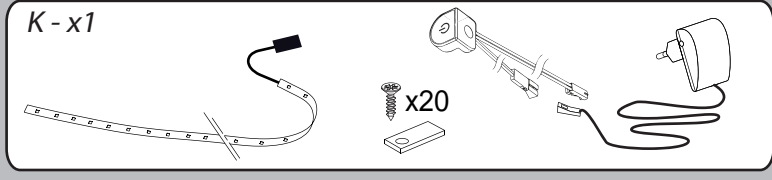

Ce luminaire est un produit de décoration.
 Ce luminaire ne convient pas pour l'illumination d'une pièce d'un ménage.
 This light is a decoration product.
 This light is not suitable for lighting a room in a house.

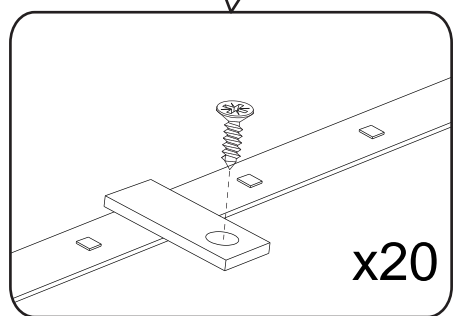
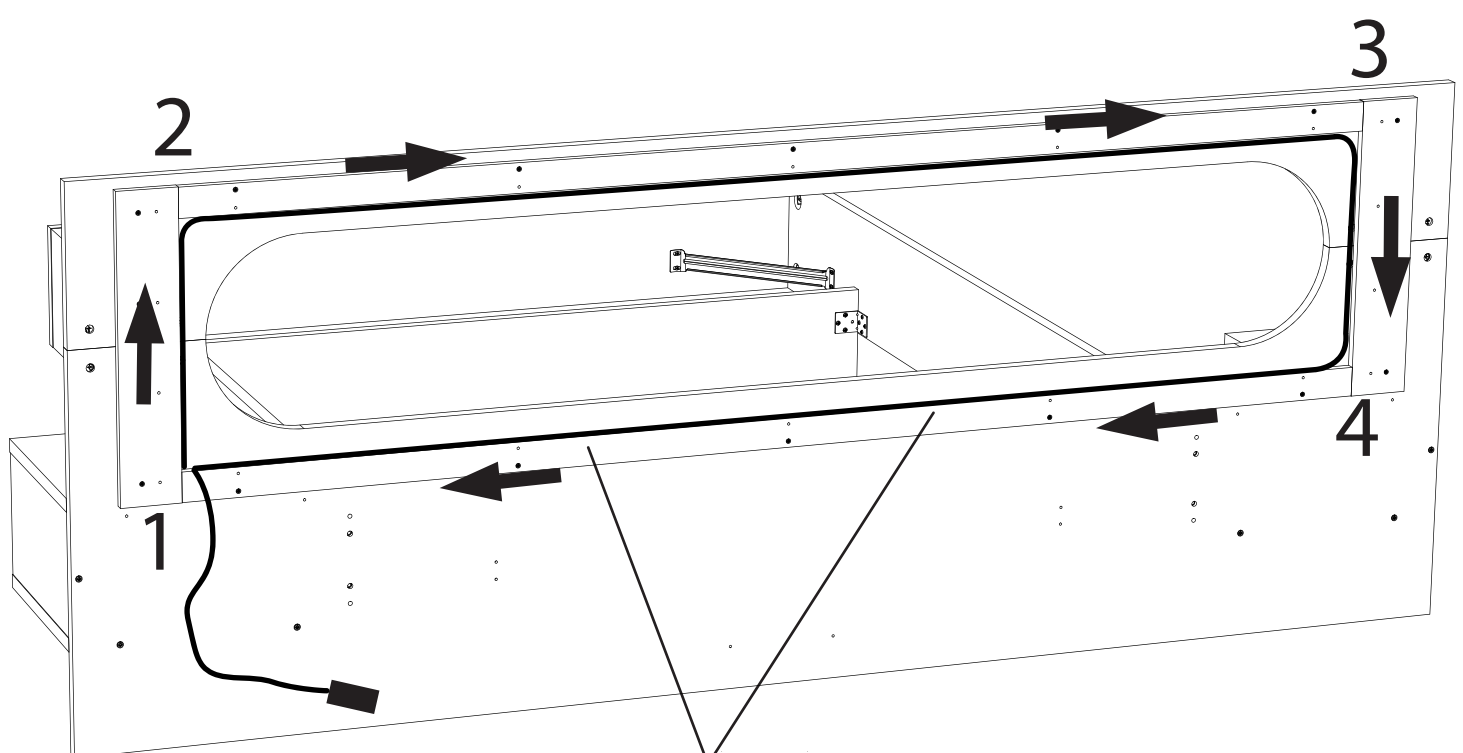
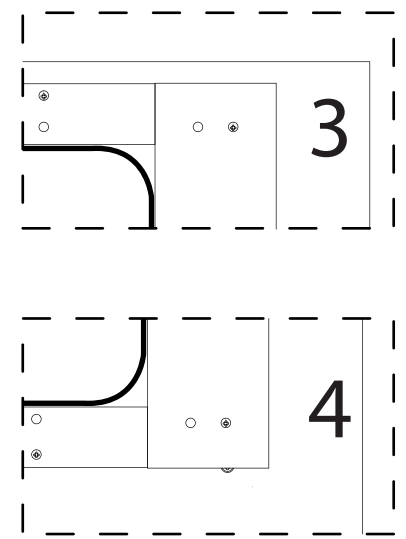
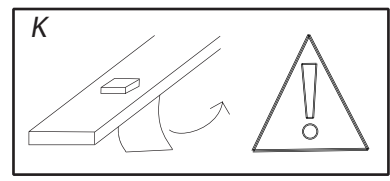
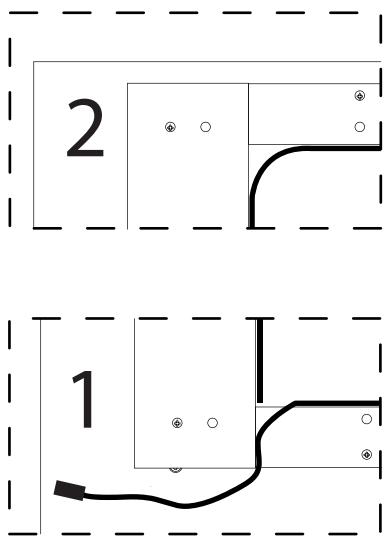

**VISSER DOUCEMENT
 SCREW GENTLY**

19

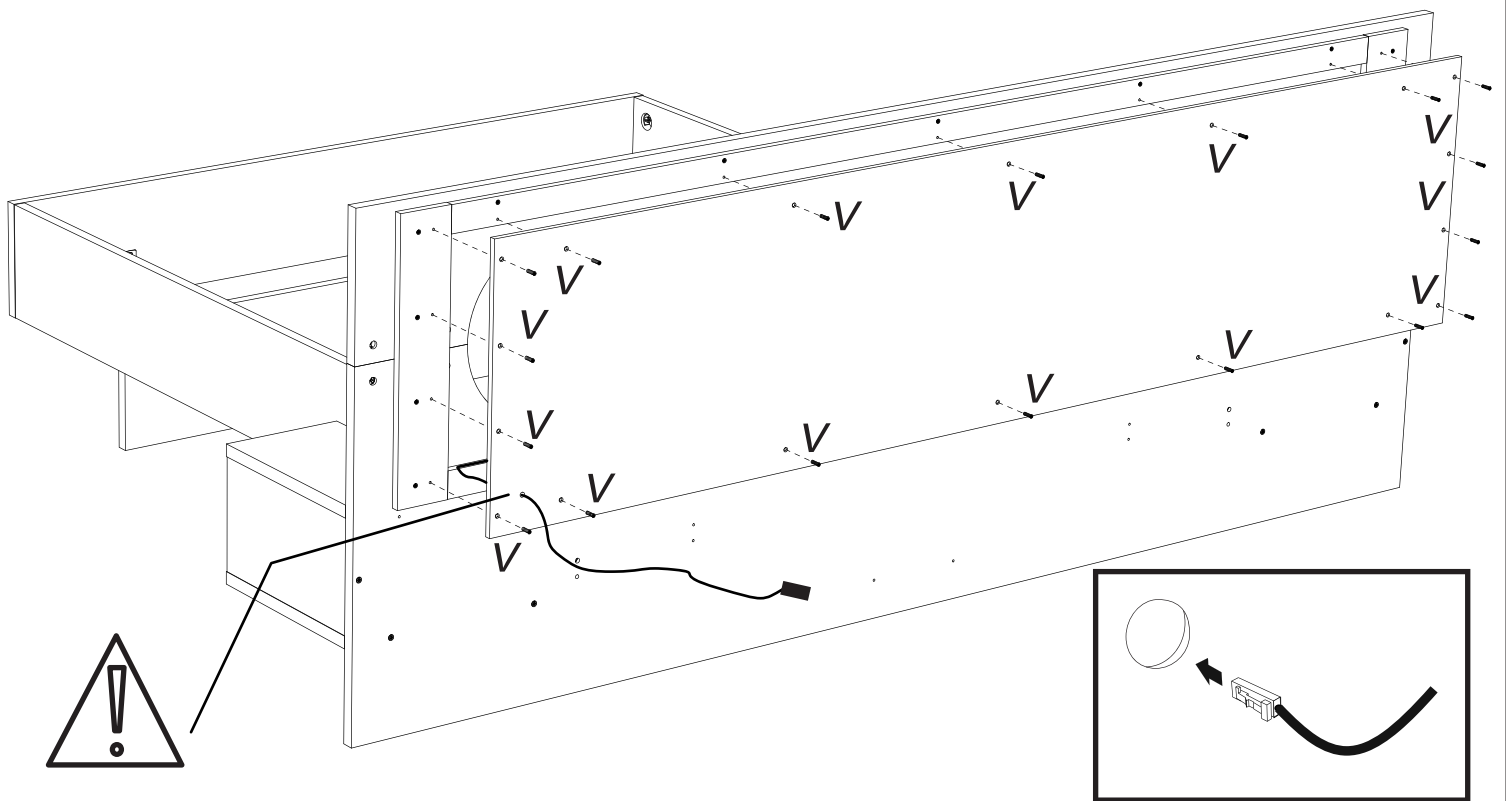
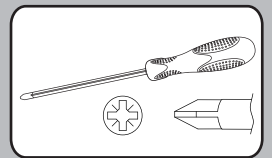
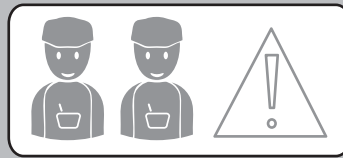
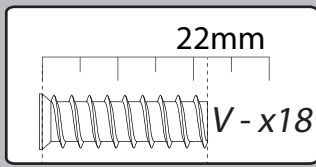

20

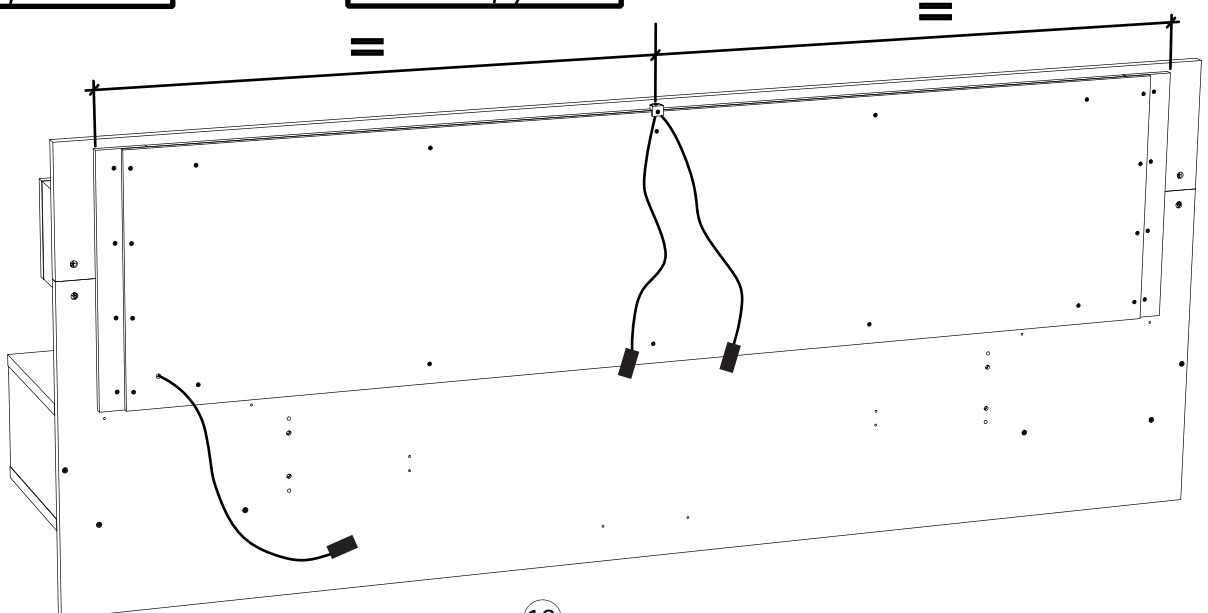
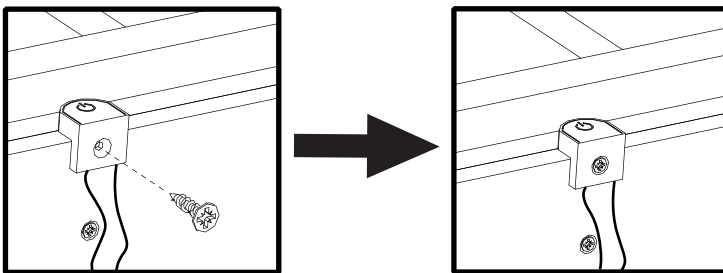
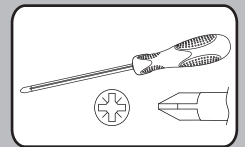
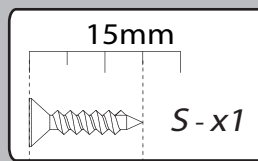
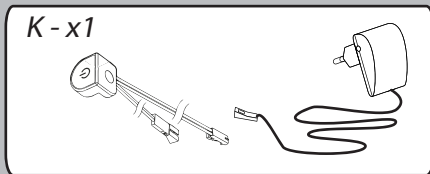

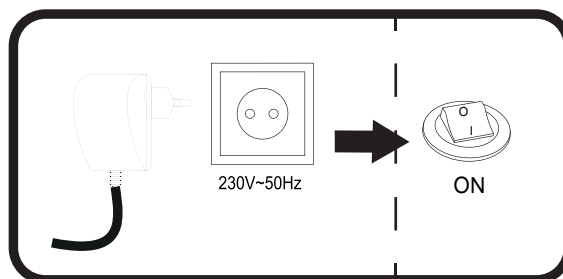
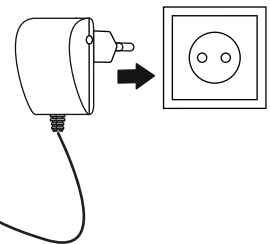
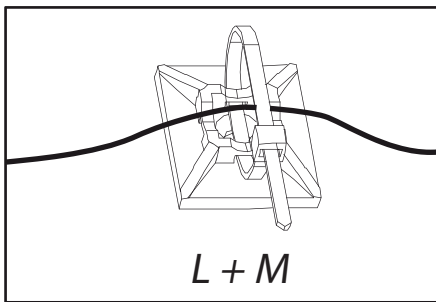
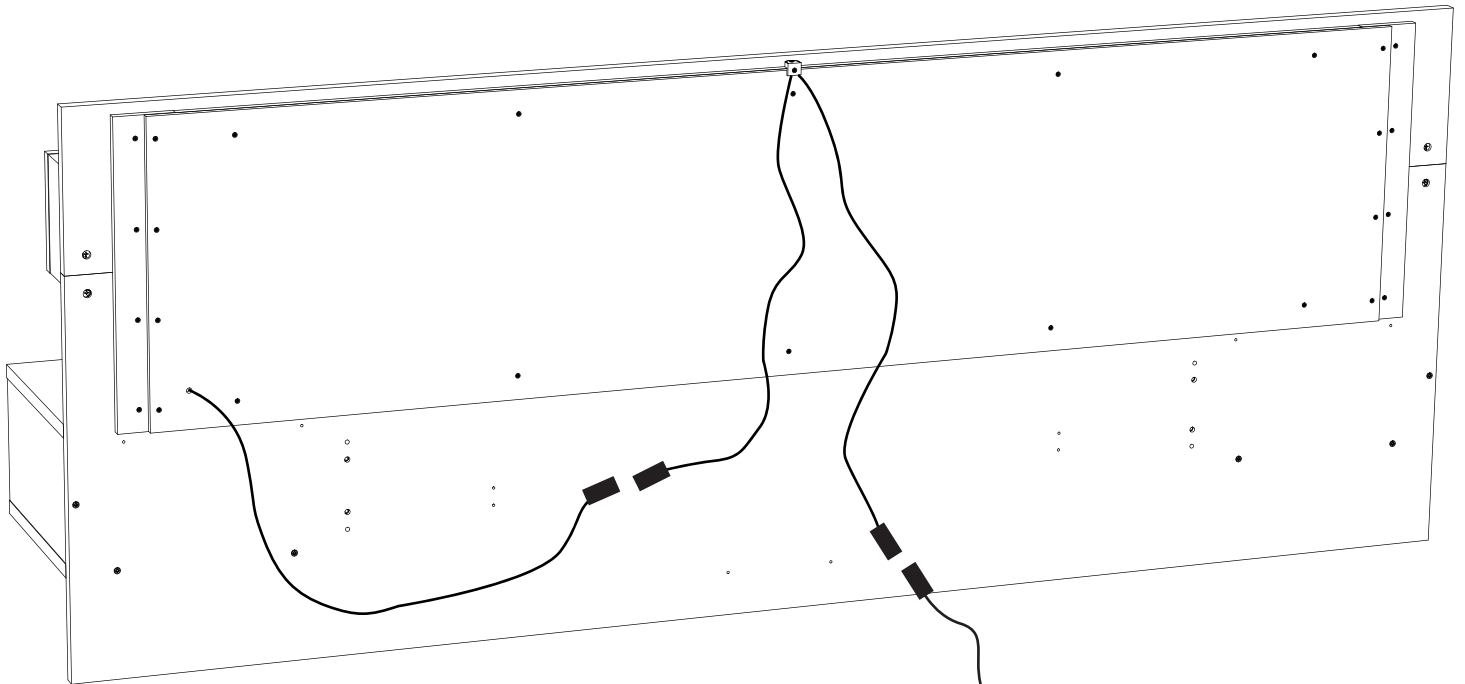
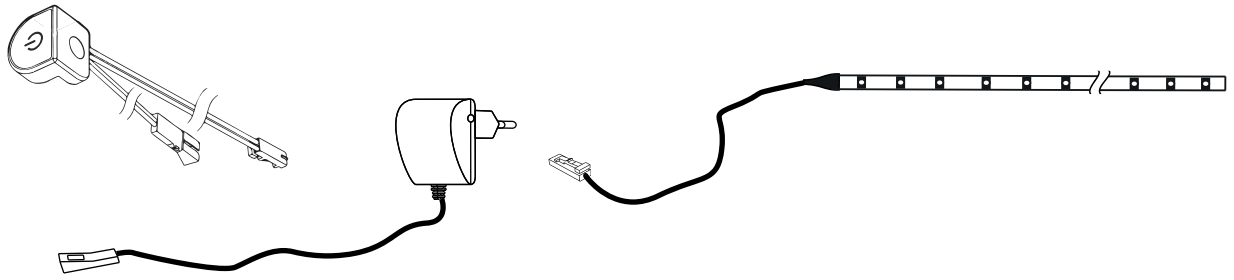
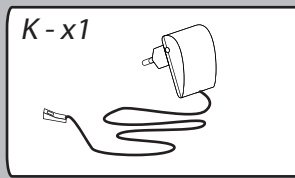
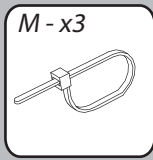
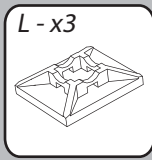

AVEIRO 0836:

Lit composé de panneaux de particules revêtus papier décor Chêne perlé et papier blanc (laqués blanc brillant pour les portes).

Lit 140 - L.244 cm - H.103 cm - P.199 cm.

Lit 160 - L.264 cm - H.103 cm - P.209 cm.

A monter soi-même.

AVEIRO 0838:

Lit composé de panneaux de particules revêtus papier décor Chêne perlé et papier noir (laqués noir brillant pour les portes).

Lit 140 - L.244 cm - H.103 cm - P.199 cm.

Lit 160 - L.264 cm - H.103 cm - P.209 cm.

A monter soi-même.

FRANCAIS

Recommandations de démontage :

En cas de déménagement, il convient de procéder au démontage de votre meuble, en ôtant toute la visserie.

ENGLISH

Disassembly advices:

In case of moving, it is needed to dismantle the furniture removing the fittings.

DEUTSCH

Empfehlungen für die Demontage:

Bei Transport bitte alle Beschläge demontieren.

"Les meubles contenant des panneaux à base de bois (panneaux de particules, panneaux de fibres, contreplaqué...) peuvent émettre des substances polluantes dans l'air intérieur. Il est ainsi recommandé, après l'installation du meuble dans son logement, d'aérer fréquemment la pièce concernée pendant au moins quatre semaines afin de réduire son exposition aux polluants émis par le meuble."