















A	B	C	D
1	1796x346	S19-1322	2/7
2	791x350	S19-2061	2/7
3	791x350	S19-2062	2/7
4	758x325	S19-3383	2/7
5	757x325	S19-3384	2/7
6	1790x376	S19-0166	3/7
7	1818x775	S19-9982	3/7

2x  c328	6x  k16	8x  φ7x50 mm e1	12x  φ5 d1	8x  φ8x30 mm f1
4x  φ4x30 mm p9	6x  b1	4x  56x56,20 mm k52	16x  φ4x30 mm p21	4x  φ15x12mm #16 r1
50x  l1	4x  r16	4x  ø16 s2	1x  z1	

1

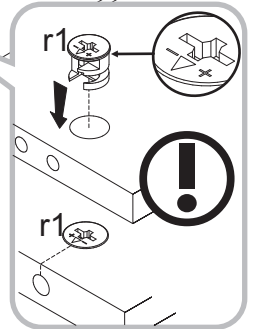
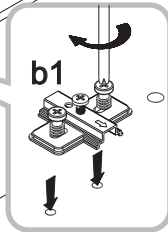
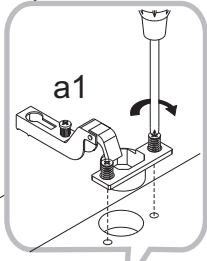
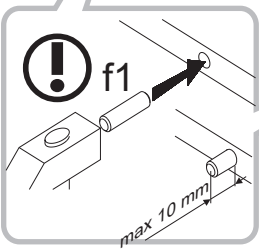
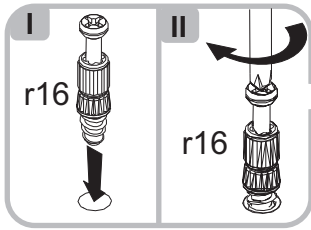
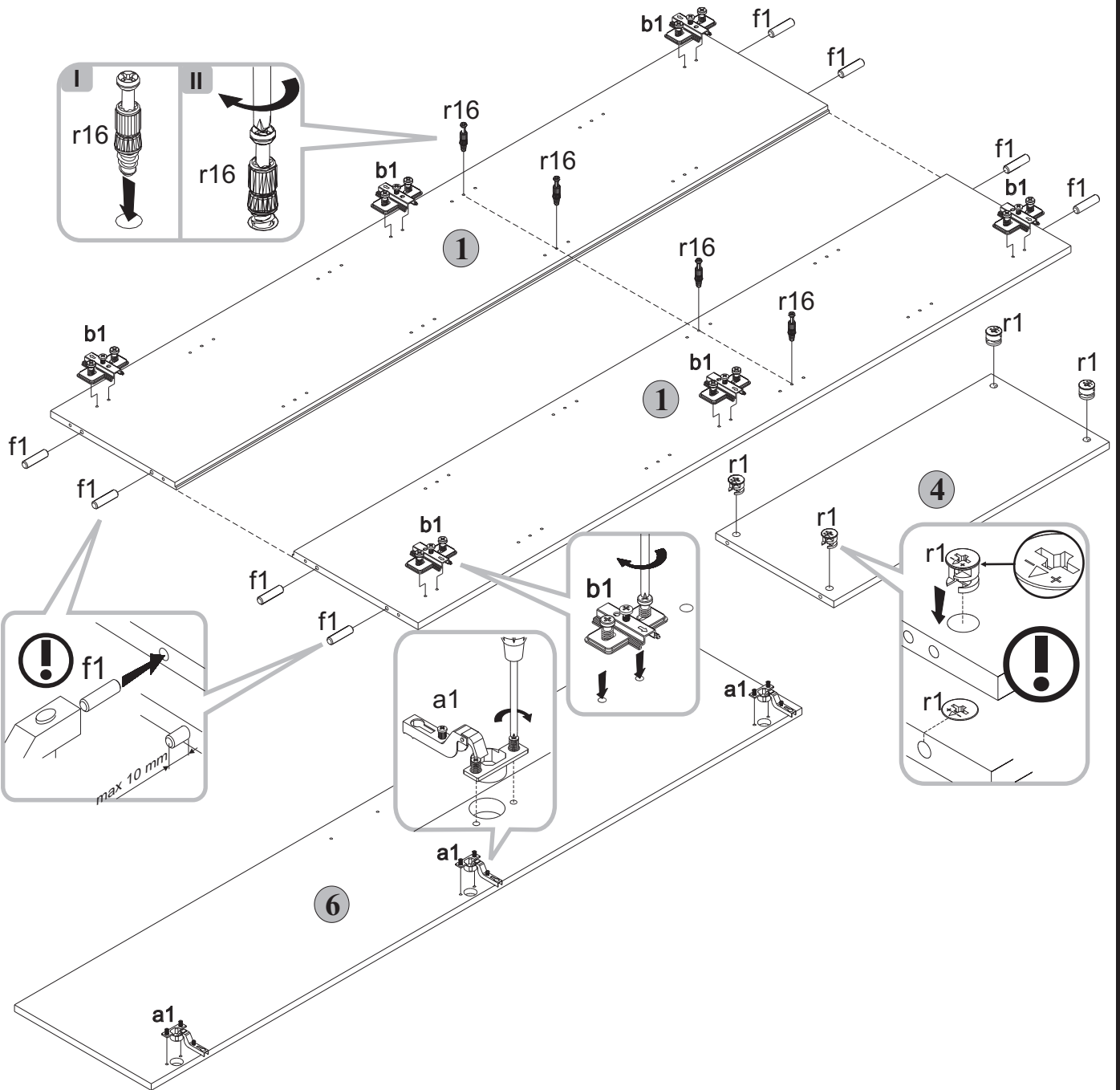

2

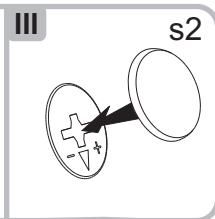
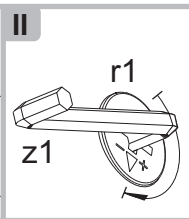
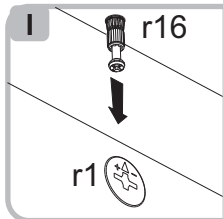
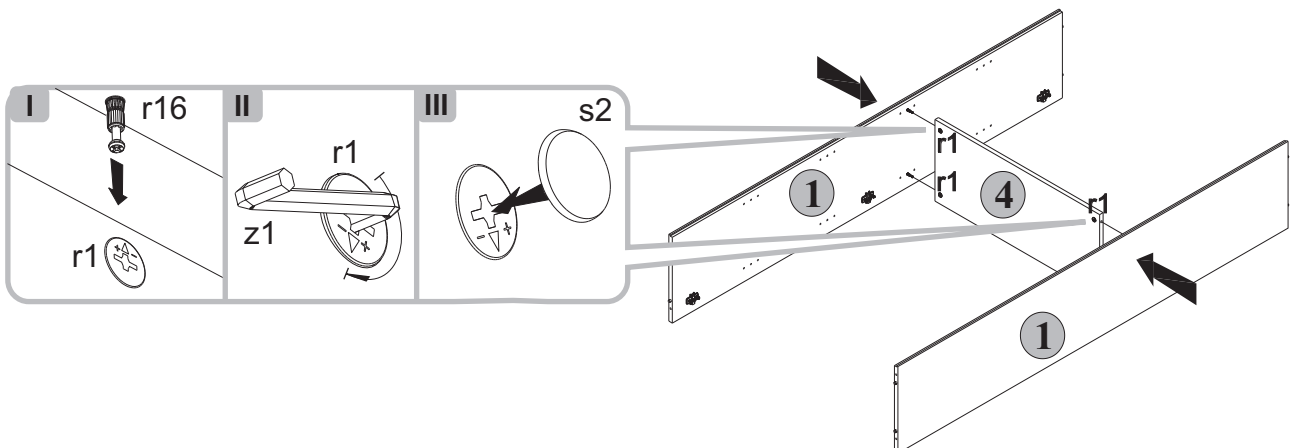

3

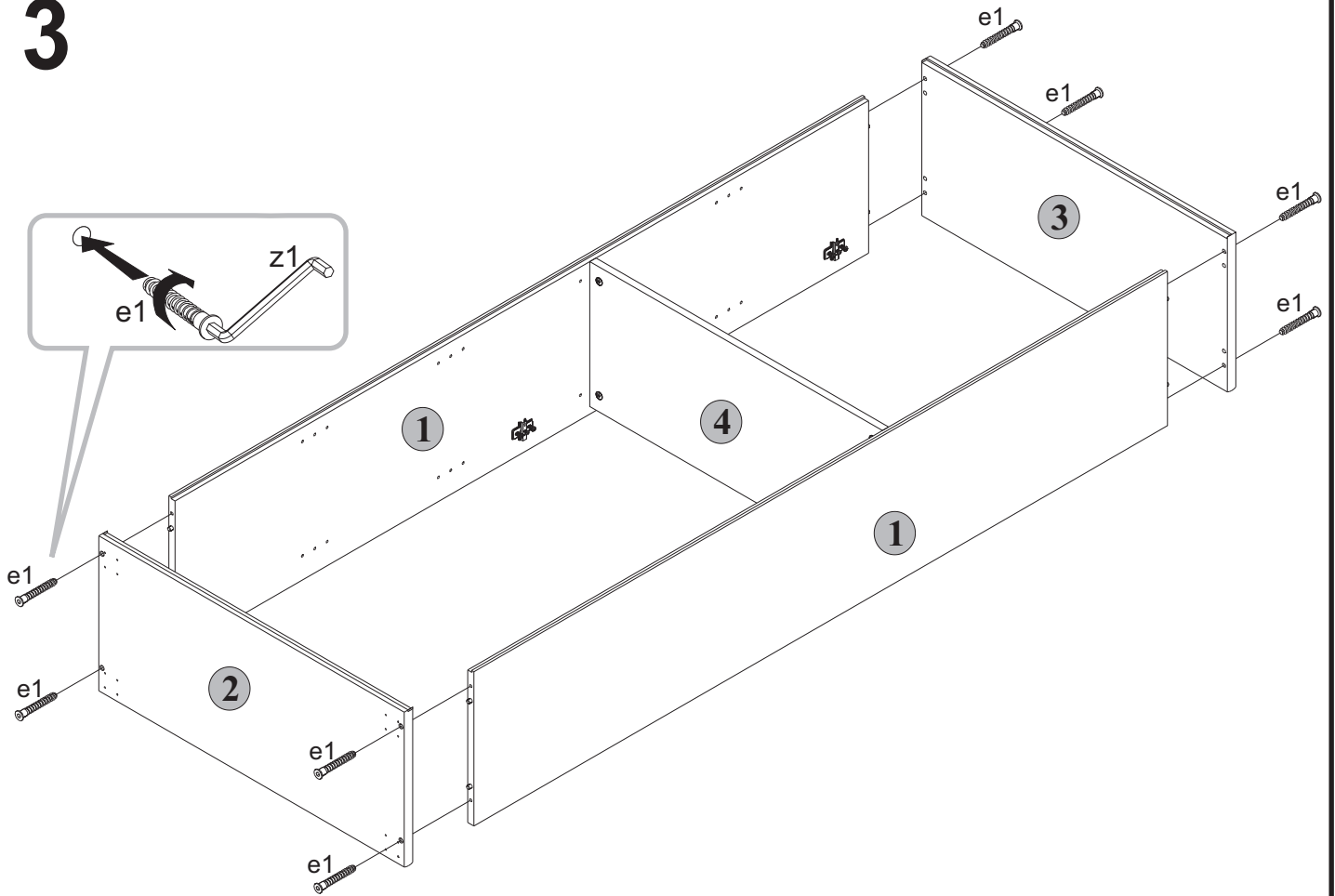

4

