

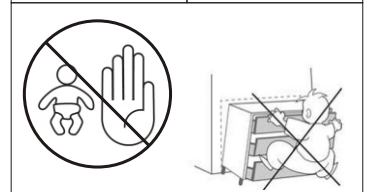

wyprodukowano dla / made for / produziert für  
**BEGA GRUPPE**  
 producent: **MEBLE OKMED POLAND**

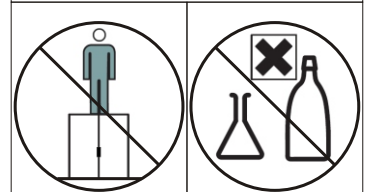

1/2				
	B	H	T	
1	687	580	16	x1
2	687	580	16	x1
11	350	110	16	x3
13	350	110	16	x3
10	362	155	16	x2
15	362	155	16	x1
5	367	60	16	x2
9	670	250	16	x1
12	328	95	16	x3
4	367	545	16	x1

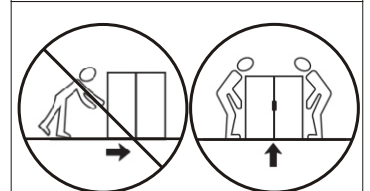
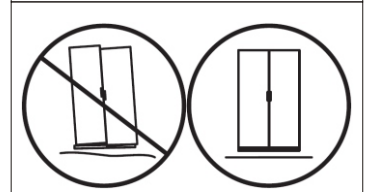
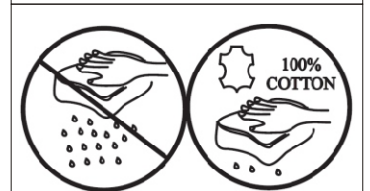
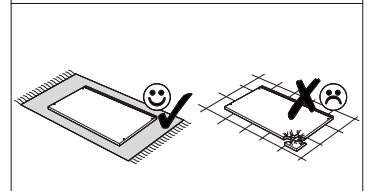
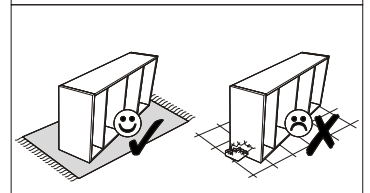
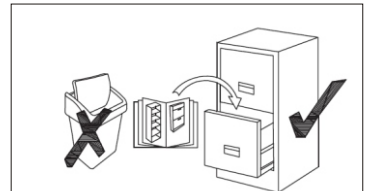
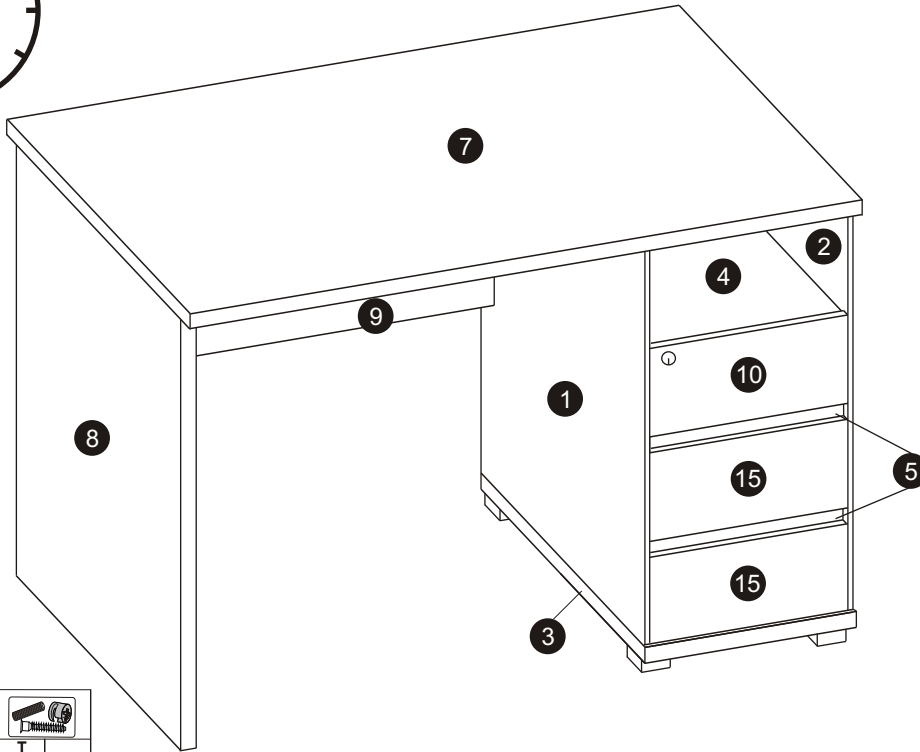
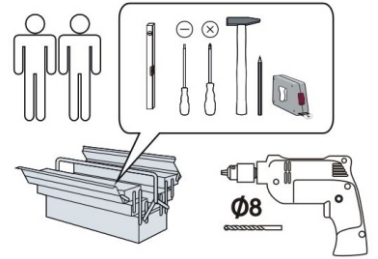
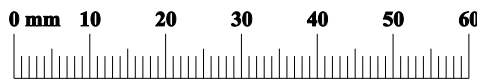

2/2				
	B	H	T	
7	1100	650	22	x1
8	725	580	22	x1
3	400	600	22	x1
14	355	343	3	x3
6	700	385	3	x1

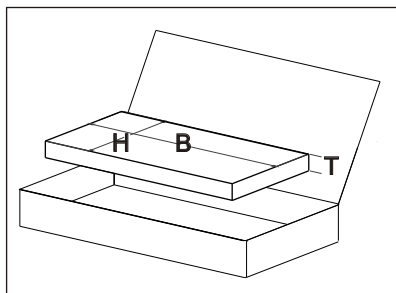

	ZM1	24		ZM1A	24		ZM1B	24		K1	10		ZK	10
	KK1	1		KD1	34		KSK1	1		W1	15		SS6	4
	PKU3	3		miniuro 4x13			M4x12			SG2	2		ZPM1	1

## 01

ZM1A	12	ZM1B	8	KD1	12	PKU3	3	ME1	12	SS6	4
ZPM1	1										

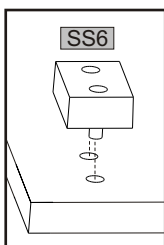
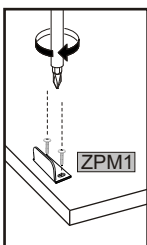
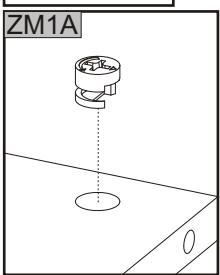
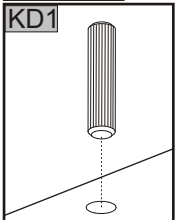
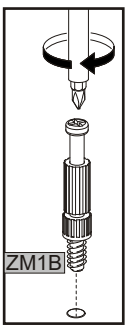
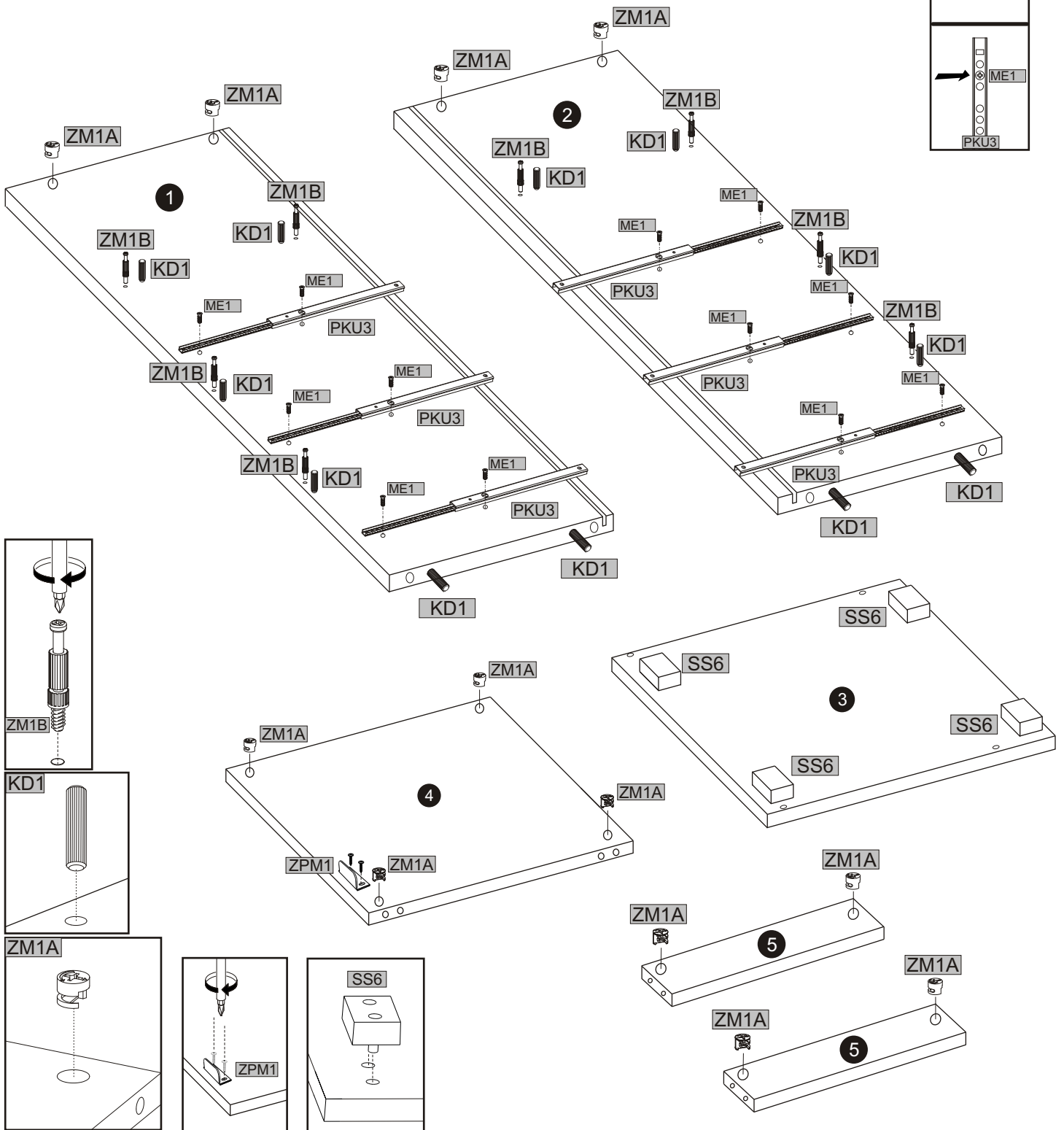
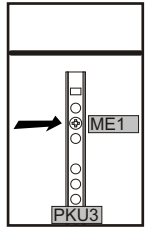
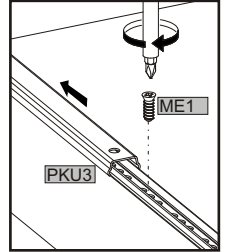
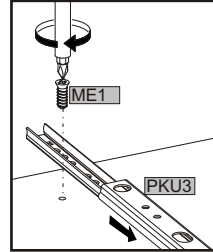
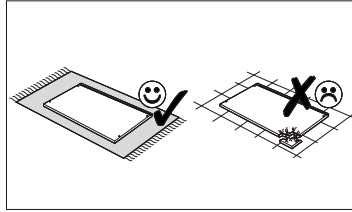
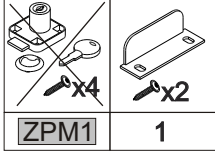





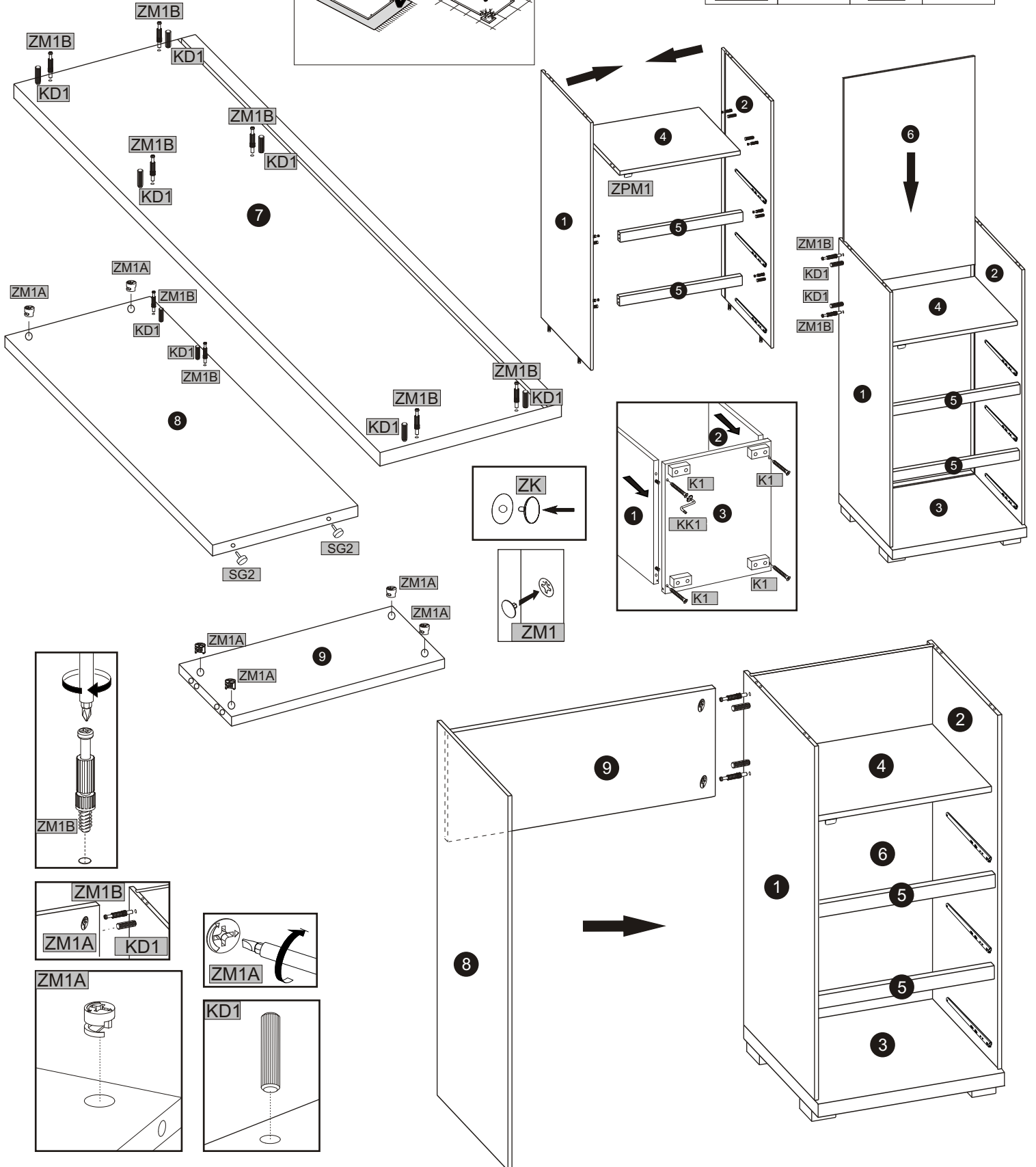
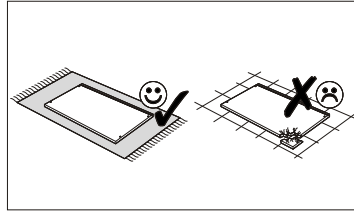

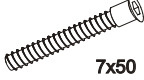
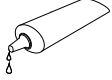

## 02

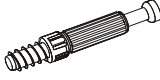
ZM1A	ZM1B	KD1	SG2	K1	KK1
6	10	10	2	4	1
ZM1	ZK				
12	4				



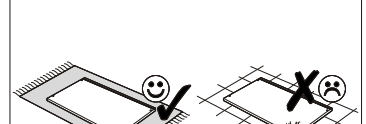

## 03

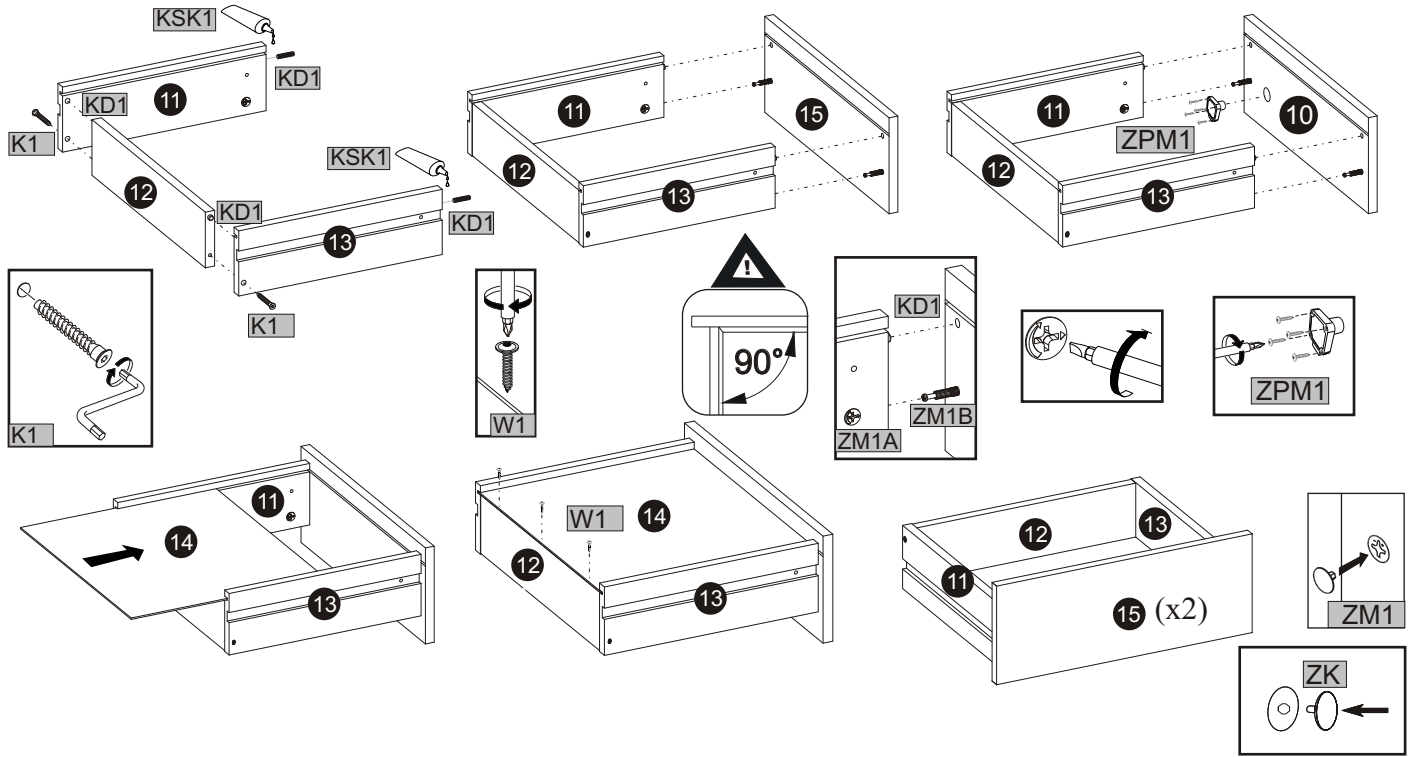
					
KK1 1	K1 6	KSK1 1	KD1 12	ZM1B 6	ZM1A 6
					
W1 9	ZM1 6	ZPM1 1	ZK 6		



## 04

	
SR4 6	ZM1 6

