



D

Wichtige Sicherheitshinweise

Die Installation Ihrer neuen Leuchte darf ausschließlich von autorisierten Fachpersonen durchgeführt werden.



www.till-hilft.de

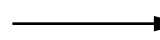

Montagehilfen



PL

Ważne wskazówki dotyczące bezpieczeństwa

Ta instalację nowej lampy mogą przeprowadzać wyłącznie autoryzowani instalatorzy



www.till-hilft.de

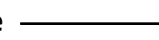

Montagehilfen



GB

Important safety instructions

The installation of your new luminaire may only be carried out by authorized specialists.



www.till-hilft.de

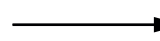

Montagehilfen



SK

Dôležité bezpečnostné upozornenia

Inštaláciu lampy smú vykonať výhradne autorizovani



www.till-hilft.de

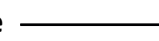

Montagehilfen



FR

signes de sécurité importantes

La L'installation votre nouveau luminaire doit uniquement être réalisée par des spécialistes autorisés



www.till-hilft.de

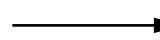

Montagehilfen



HU

Fontos biztonsági utmutatások

Az On Új lámpájának beszerelését kizárólag hivatalos szakember végezheti el



www.till-hilft.de

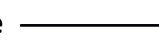

Montagehilfen



IT

Important disposizioni di sicurezza

L'installazione della il loro nuovo lampada può essere eseguita solo ed esclusivamente da personale tecnico autorizzato.



www.till-hilft.de

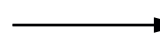

Montagehilfen



RO

Instrucțiuni de siguranță importante

Instalarea noii dumneavoastră lămpi este permisă exclusiv specialișilor autorizați



www.till-hilft.de

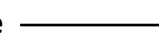

Montagehilfen



NL

Belangrijke veiligheidsaanwijzingen

De installatie van de nieuwe lamp moet worden uitgevoerd door vakbekwame personen worden uitgevoerd.



www.till-hilft.de

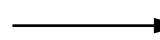

Montagehilfen



TR

Önemli güvenlik uyarıları

Yeni lamba montajı yetkin kişiler tarafından yapılmalıdır



www.till-hilft.de

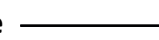

Montagehilfen



CZ

Důležité bezpečnostní pokyny

Instalaci nových svídel smí provádět pouze kvalifikovaný elektrikář



www.till-hilft.de

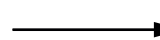

Montagehilfen



RU

важная информация по технике безопасности

Установка вашей новой лампы должна выполняться квалифицированным персоналом



www.till-hilft.de

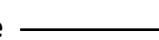

Montagehilfen



89904.330



1 4 x 2802	2 4 x 2801	3 2 x 1946	4 3 x 13,5 4 x 1123	5 8 x 30 14 x 2861
6 3 x 15 1 x 2803	7 1 x 5325	8 1 x 5325.100	9 1 x 5325.200	10 2 x 5325.300
11 Leim 1 x 2863	12 8 x 30 2 x 2842	13 5,8 x 55 2 x 2840		

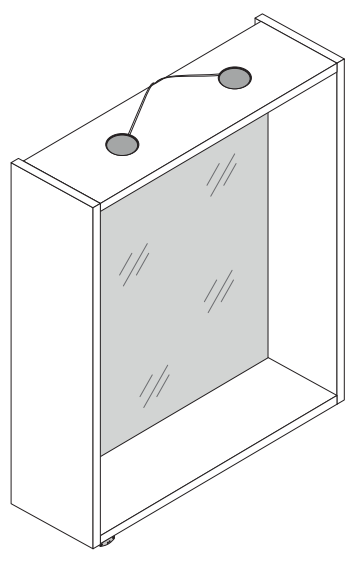
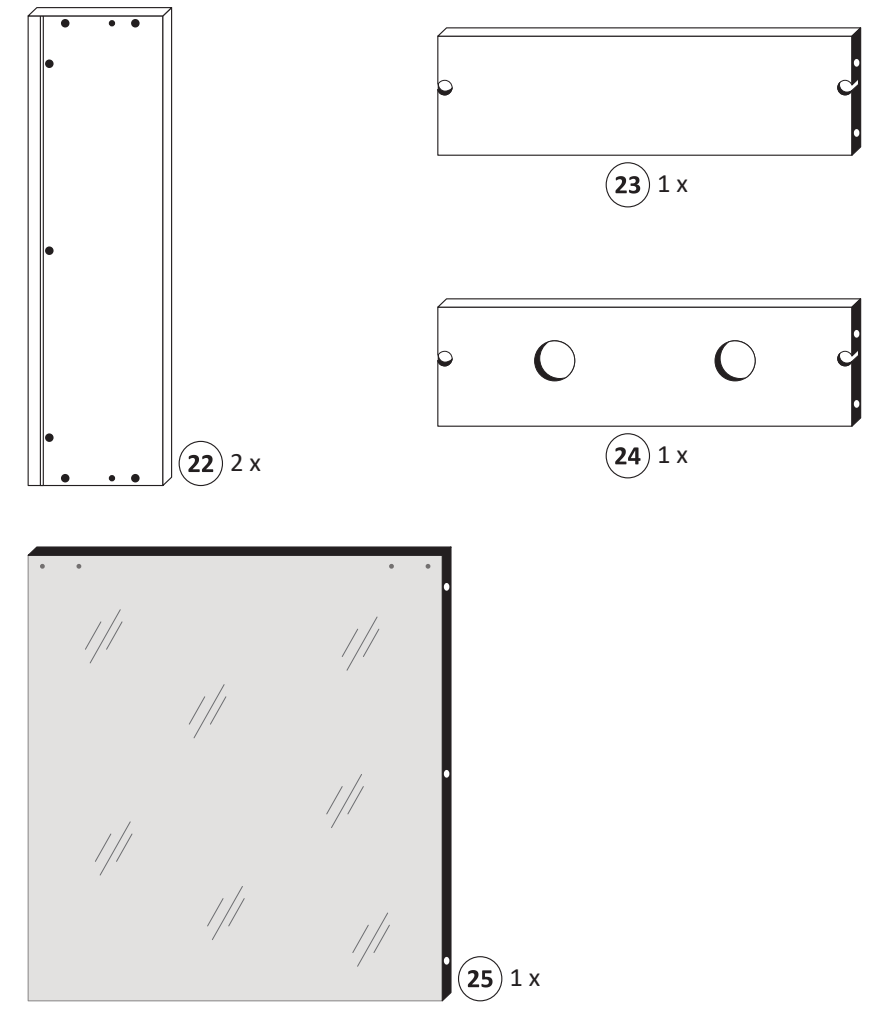
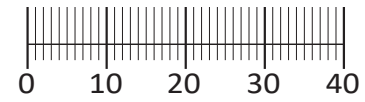

88701.331

Das beigefügte Wandbefestigungsmaterial (Dübel und Schrauben) eignet sich nur für festes Mauerwerk (z.B.: Beton- oder Ziegelwände). Für andere Wandaufbauten sind eventuell Spezialdübel und andere Schrauben notwendig. Ziehen Sie gegebenenfalls eine Fachkraft zu Rate.

De begeleidende wandmontage hardware (pluggen en schroeven) is alleen geschikt voor massief metselwerk (bijvoorbeeld beton of bakstenen muren). Voor andere muur structuren zijn eventueel bijzondere ankerbouten en andere noodzakelijke. Draai indien nodig, een deskundige.

Приложенный материал для крепления к стене (дюбели и винты) пригоден только для жестких кладок (например, бетонные или кирпичные стены). Для других настенных конструкций необходимы смотря по обстоятельствам специальные дюбели и другие винты. При необходимости проконсультируйтесь у специалиста.

Le mur d'accompagnement matériel de montage (chevilles et les vis) ne convient que pour la maçonnerie solide (par exemple en béton ou des murs de briques). Pour les structures de mur d'autres sont peut-être spéciale boulons d'ancrage et d'autres nécessaires. Serrer le cas échéant, un expert.

Załączony materiał do mocowania do ściany (kolki rozprężne i wkręty) nadaje się tylko do ścian murowanych (np. z betonu lub cegiel). Do ścian wykonanych w innych technologiach konieczne być mogą specjalne kolki rozprężne i inne wkręty. W razie potrzeby skorzystaj z fachowej pomocy

Il muro di accompagnamento hardware di montaggio (tasselli e viti) è adatto solo per muratura piena (ad esempio calcestruzzo o muratura). Per le altre strutture murarie sono forse speciali bulloni di ancoraggio e necessari di altri. Serrare se necessario, un esperto.

The accompanying wall mounting hardware (anchors and screws) is suitable only for solid masonry (eg concrete or brick walls). For other wall structures are possibly special anchor bolts and other necessary. Tighten if necessary, an expert.

Ekteki duvara sabit montaj malzemeleri (dübel ve vidalar), sadece sağlam duvarlar için (örnek: beton veya tuğla) elverişlidir. Başka duvarlar için özel dübeller ve farklı vidalar gerekebilir. Gerektiğinde bir uzmana danışınız.

1

1 4 x 2802

22 2x

2

2 4 x 2801

5 8 x 30 8 x 2861

11 Leim 1 x 2863

23

24

3

3 2 x 1946

4 3 x 13,5 4 x 1123

5 8 x 30 14 x 2861

11 Leim 1 x 2863

25

oben

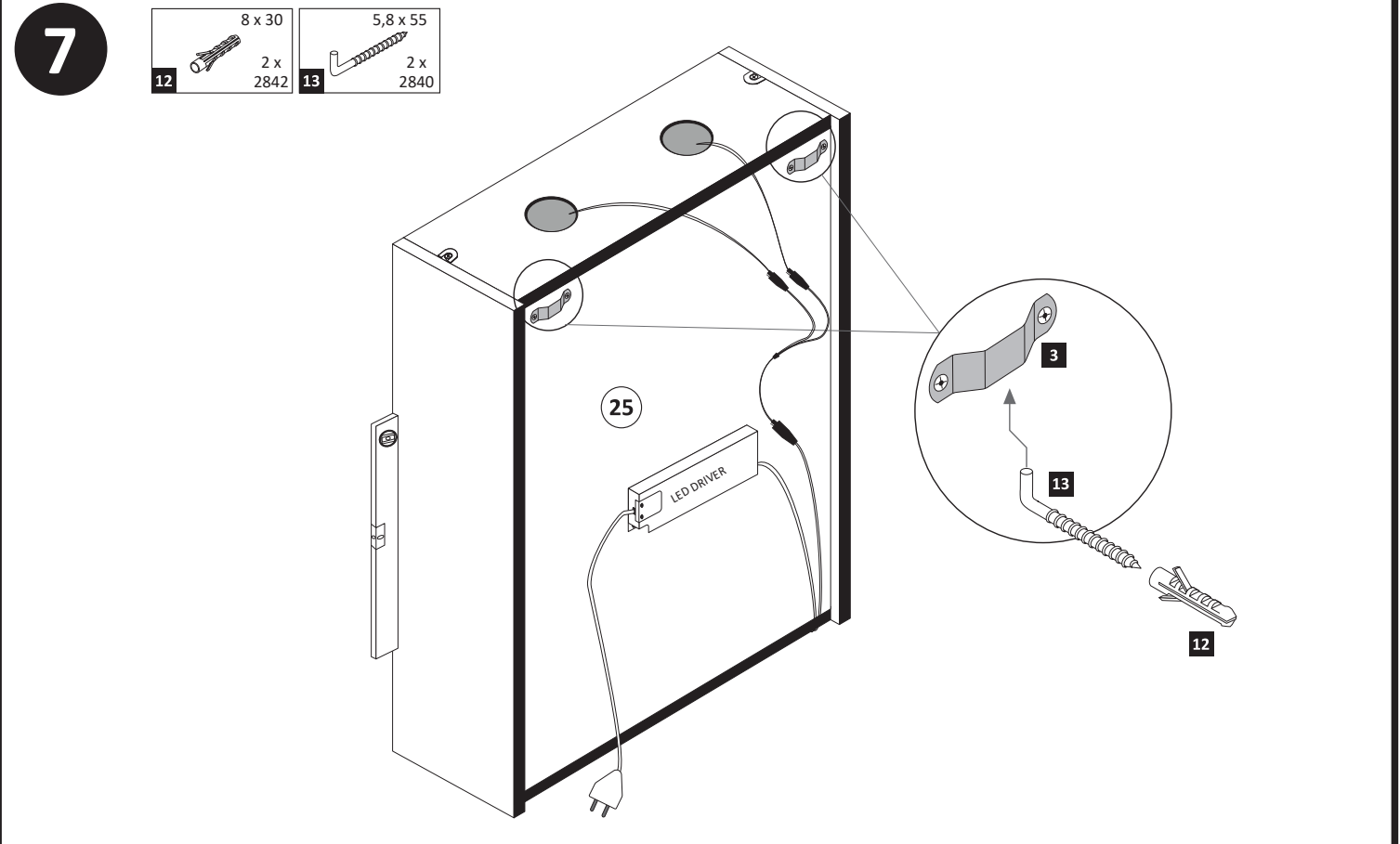
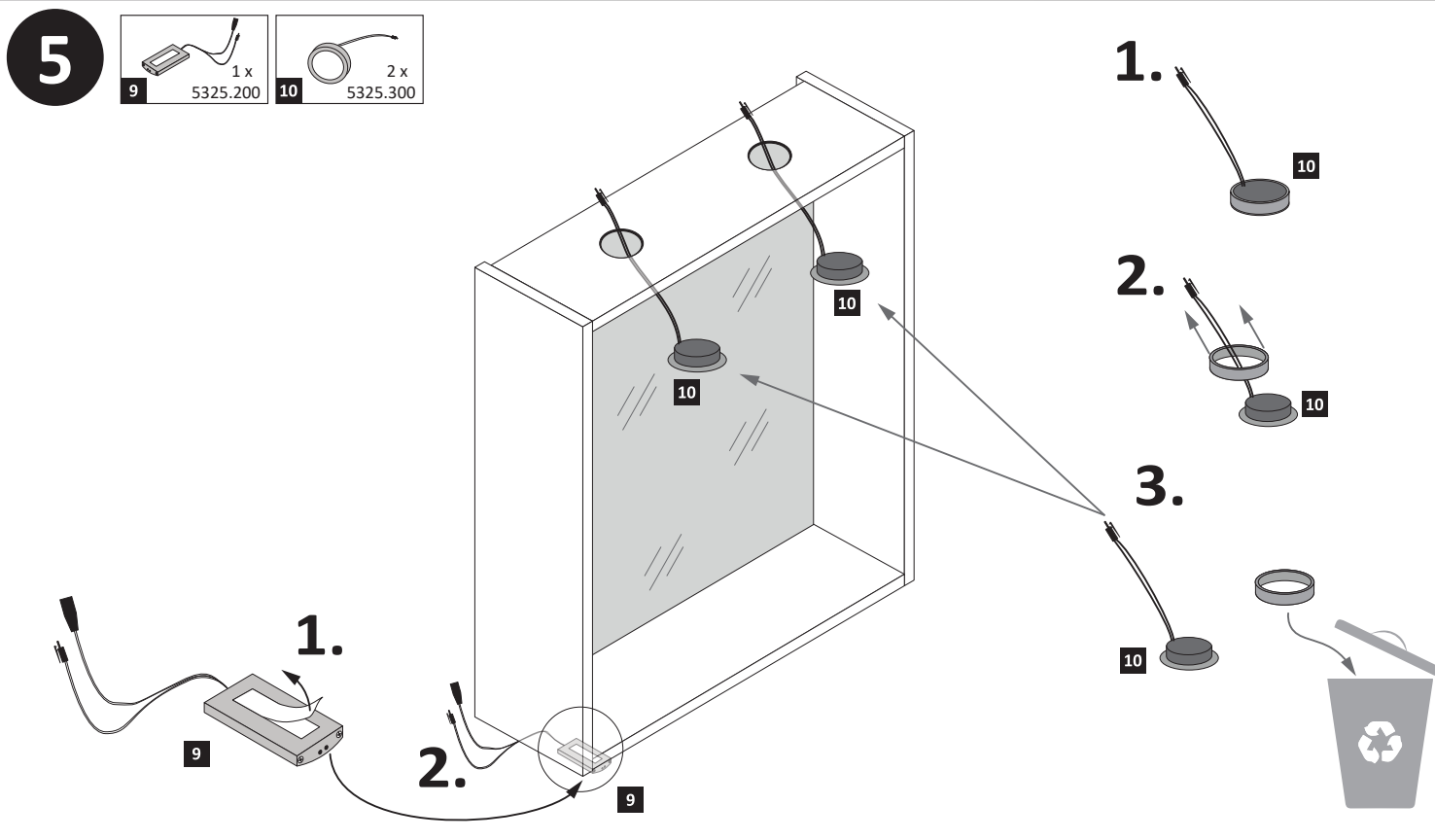
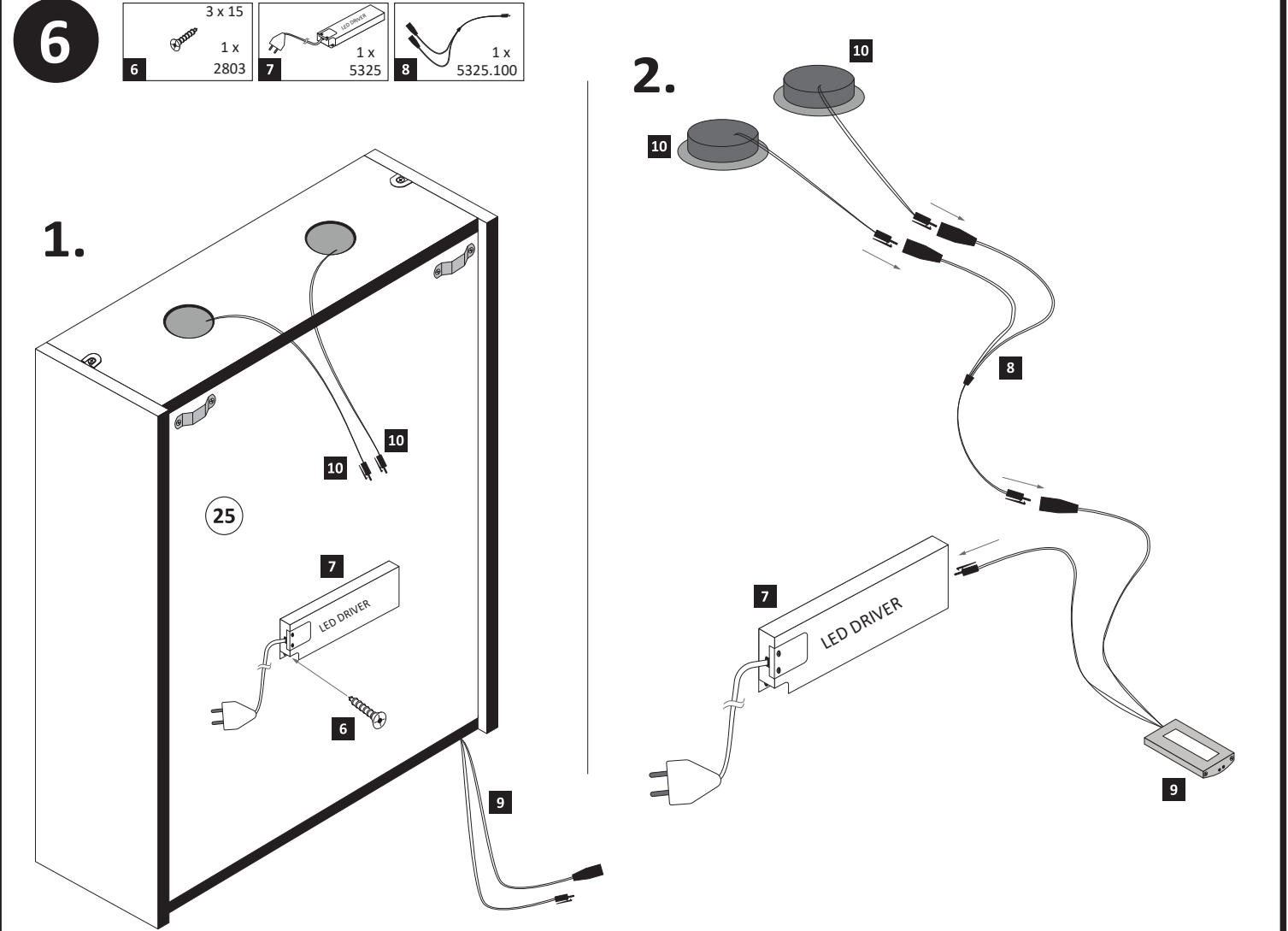
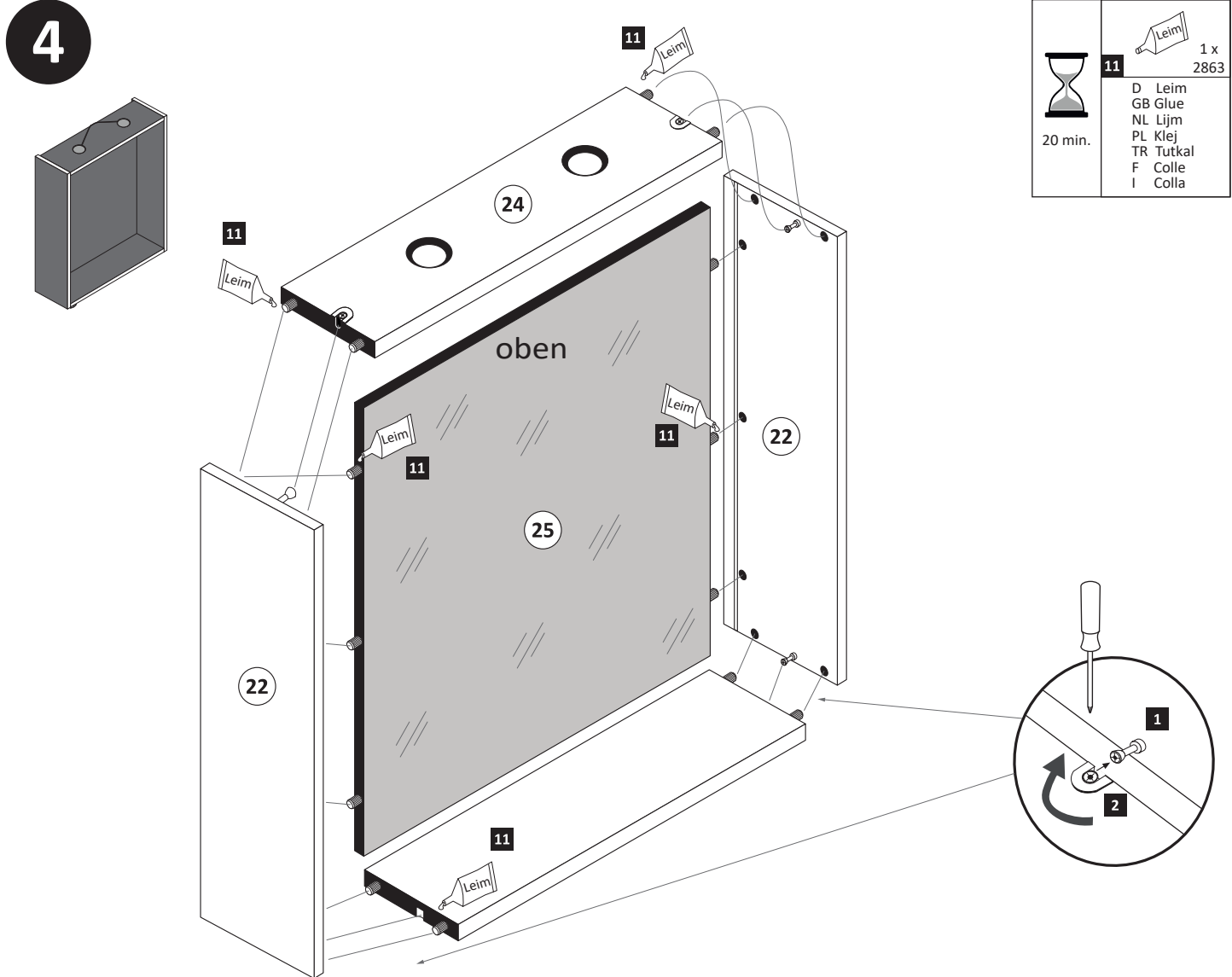



1 4 x 2802	2 4 x 2801	3 2 x 1946	4 3 x 13,5 4 x 1123	5 8 x 30 14 x 2861
6 3 x 15 1 x 2803	7 1 x 5325	8 1 x 5325.100	9 1 x 5325.200	10 2 x 5325.300
11 Leim 1 x 2863	12 8 x 30 2 x 2842	13 5,8 x 55 2 x 2840		

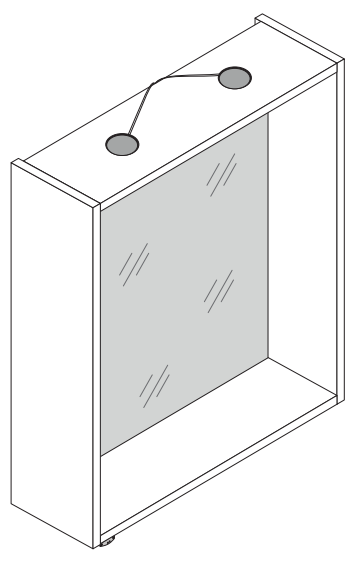
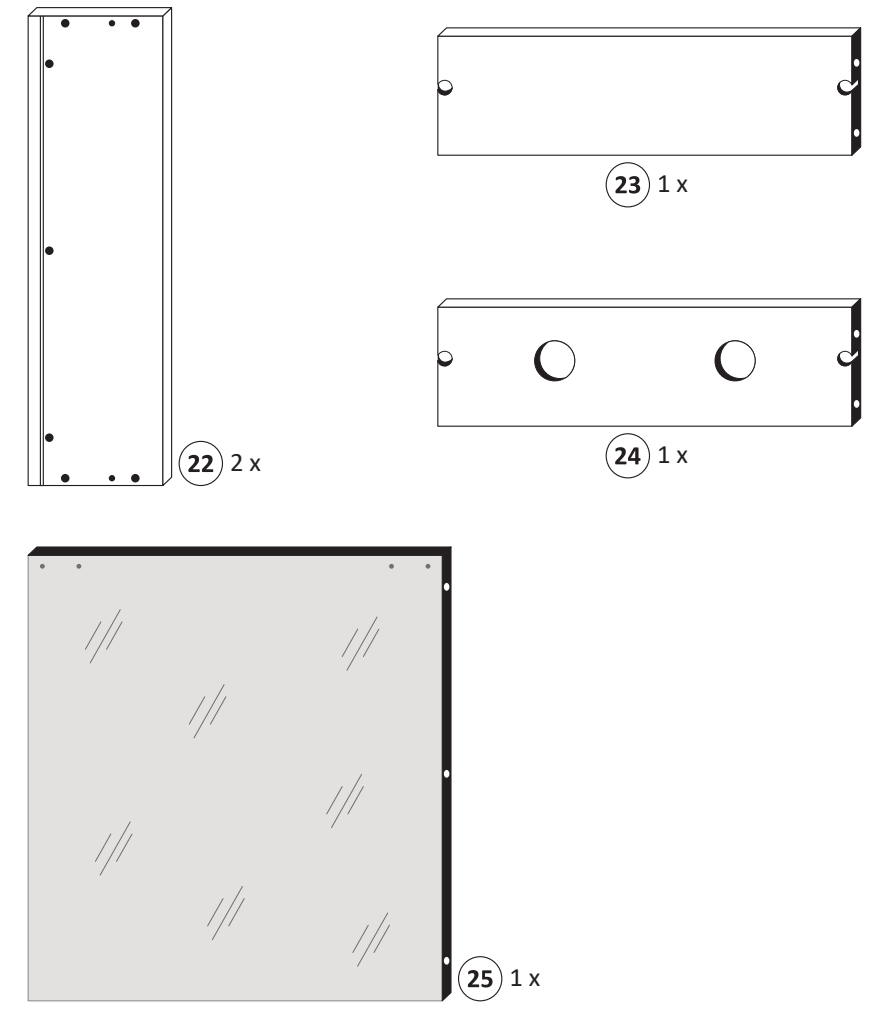
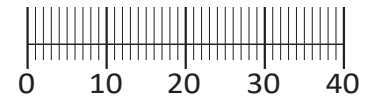

88701.331

Das beigefügte Wandbefestigungsmaterial (Dübel und Schrauben) eignet sich nur für festes Mauerwerk (z.B.: Beton- oder Ziegelwände). Für andere Wandaufbauten sind eventuell Spezialdübel und andere Schrauben notwendig. Ziehen Sie gegebenenfalls eine Fachkraft zu Rate.

De begeleidende wandmontage hardware (pluggen en schroeven) is alleen geschikt voor massief metselwerk (bijvoorbeeld beton of bakstenen muren). Voor andere muur structuren zijn eventueel bijzondere ankerbouten en andere noodzakelijke. Draai indien nodig, een deskundige.

Приложенный материал для крепления к стене (дюбели и винты) пригоден только для жестких кладок (например, бетонные или кирпичные стены). Для других настенных конструкций необходимы смотря по обстоятельствам специальные дюбели и другие винты. При необходимости проконсультируйтесь у специалиста.

Le mur d'accompagnement matériel de montage (chevilles et les vis) ne convient que pour la maçonnerie solide (par exemple en béton ou des murs de briques). Pour les structures de mur d'autres sont peut-être spéciale boulons d'ancrage et d'autres nécessaires. Serrer le cas échéant, un expert.

Załączony materiał do mocowania do ściany (kolki rozprężne i wkręty) nadaje się tylko do ścian murowanych (np. z betonu lub cegieł). Do ścian wykonanych w innych technologiach konieczne być mogą specjalne kolki rozprężne i inne wkręty. W razie potrzeby skorzystaj z fachowej pomocy

Il muro di accompagnamento hardware di montaggio (tasselli e viti) è adatto solo per muratura piena (ad esempio calcestruzzo o muratura). Per le altre strutture murarie sono forse speciali bulloni di ancoraggio e necessari di altri. Serrare se necessario, un esperto.

The accompanying wall mounting hardware (anchors and screws) is suitable only for solid masonry (eg concrete or brick walls). For other wall structures are possibly special anchor bolts and other necessary. Tighten if necessary, an expert.

Ekteki duvara sabit montaj malzemeleri (dübel ve vidalar), sadece sağlam duvarlar için (örnek: beton veya tuğla) elverişlidir. Başka duvarlar için özel dübeller ve farklı vidalar gerekebilir. Gerektiğinde bir uzmana danışınız.

1

1 4 x 2802

2

2 4 x 2801 5 8 x 30 8 x 2861 11 1 x 2863

3

3 2 x 1946 4 3 x 13,5 4 x 1123 5 8 x 30 14 x 2861 11 1 x 2863

oben

4

Leim

oben

24

25

22

11

11

11

11

11

11

1

2

	11	1 x 2863
		D Leim
		GB Glue
		NL Lijm
		PL Klej
		TR Tutkal
		F Colle
		I Colla

20 min.

6

1.

2.

3 x 15

6

1 x 2803

7

1 x 5325

8

1 x 5325.100

10

10

10

7

LED DRIVER

6

9

7

LED DRIVER

8

9

5

1.

2.

9

1 x 5325.200

10

2 x 5325.300

10

10

10

10

10

10

10

10

9

9

1.

2.

7

1.

2.

3.

12

8 x 30

2 x 2842

13

5,8 x 55

2 x 2840

25

LED DRIVER

3

13

12



1 4 x 2802	2 4 x 2801	3 2 x 1946	4 3 x 13,5 4 x 1123	5 8 x 30 14 x 2861
6 3 x 15 1 x 2803	7 1 x 5325	8 1 x 5325.100	9 1 x 5325.200	10 2 x 5325.300
11 Leim 1 x 2863	12 8 x 30 2 x 2842	13 5,8 x 55 2 x 2840		

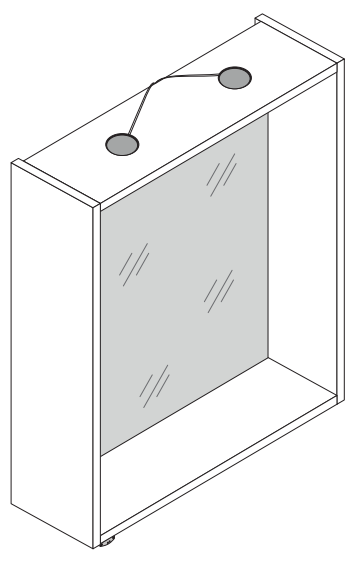
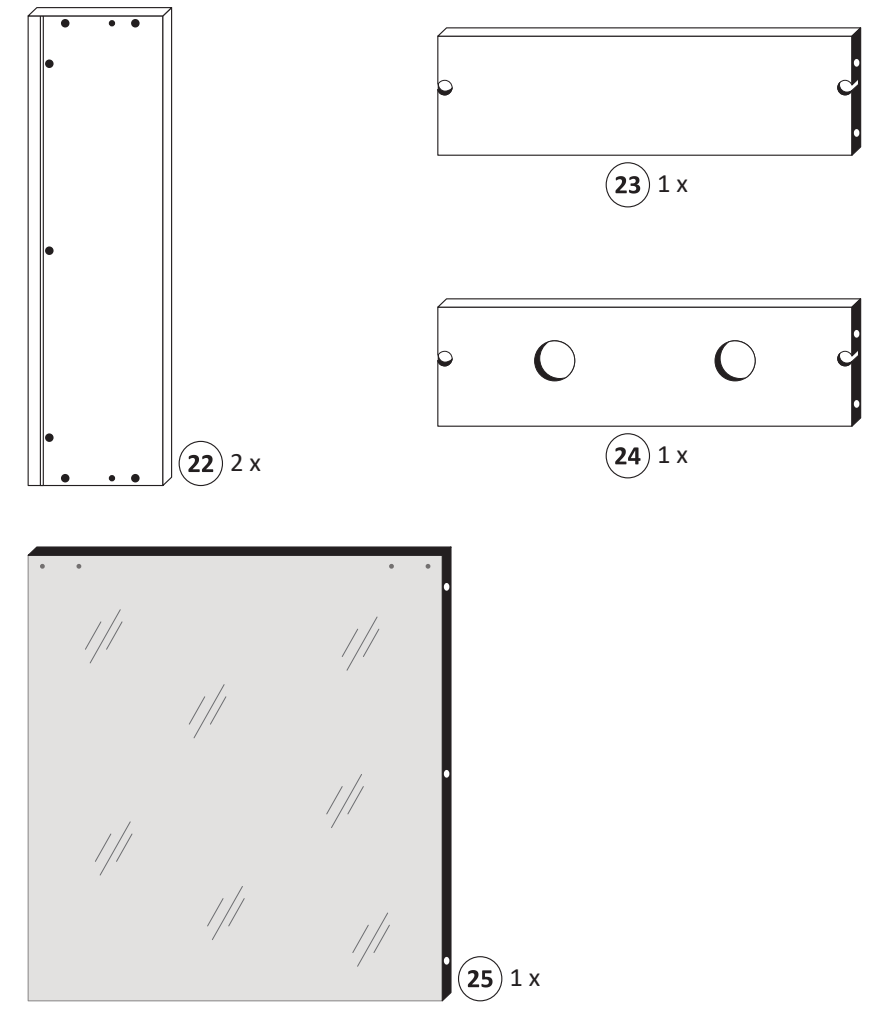
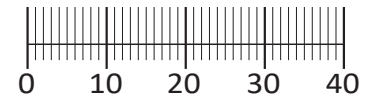

88701.331

Das beigefügte Wandbefestigungsmaterial (Dübel und Schrauben) eignet sich nur für festes Mauerwerk (z.B.: Beton- oder Ziegelwände). Für andere Wandaufbauten sind eventuell Spezialdübel und andere Schrauben notwendig. Ziehen Sie gegebenenfalls eine Fachkraft zu Rate.

De begeleidende wandmontage hardware (pluggen en schroeven) is alleen geschikt voor massief metselwerk (bijvoorbeeld beton of bakstenen muren). Voor andere muur structuren zijn eventueel bijzondere ankerbouten en andere noodzakelijke. Draai indien nodig, een deskundige.

Приложенный материал для крепления к стене (дюбели и винты) пригоден только для жестких кладок (например, бетонные или кирпичные стены). Для других настенных конструкций необходимы смотря по обстоятельствам специальные дюбели и другие винты. При необходимости проконсультируйтесь у специалиста.

Le mur d'accompagnement matériel de montage (chevilles et les vis) ne convient que pour la maçonnerie solide (par exemple en béton ou des murs de briques). Pour les structures de mur d'autres sont peut-être spéciale boulons d'ancrage et d'autres nécessaires. Serrer le cas échéant, un expert.

Załączony materiał do mocowania do ściany (kolki rozprężne i wkręty) nadaje się tylko do ścian murowanych (np. z betonu lub cegiel). Do ścian wykonanych w innych technologiach konieczne być mogą specjalne kolki rozprężne i inne wkręty. W razie potrzeby skorzystaj z fachowej pomocy

Il muro di accompagnamento hardware di montaggio (tasselli e viti) è adatto solo per muratura piena (ad esempio calcestruzzo o muratura). Per le altre strutture murarie sono forse speciali bulloni di ancoraggio e necessari di altri. Serrare se necessario, un esperto.

The accompanying wall mounting hardware (anchors and screws) is suitable only for solid masonry (eg concrete or brick walls). For other wall structures are possibly special anchor bolts and other necessary. Tighten if necessary, an expert.

Ekteki duvara sabit montaj malzemeleri (dübel ve vidalar), sadece sağlam duvarlar için (örnek: beton veya tuğla) elverişlidir. Başka duvarlar için özel dübeller ve farklı vidalar gerekebilir. Gerektiğinde bir uzmana danışınız.

1

4 x
2802

2

4 x
2801

8 x 30
8 x
2861

Leim
1 x
2863

3

2 x
1946

3 x 13,5
4 x
1123

8 x 30
14 x
2861

Leim
1 x
2863

oben

4

Leim

oben

20 min.

11	1 x	2863
D	Leim	
GB	Glue	
NL	Lijm	
PL	Klej	
TR	Tutkal	
F	Colle	
I	Colla	

6

6	3 x 15	1 x	2803
7	1 x	5325	
8	1 x	5325.100	

LED DRIVER

LED DRIVER

5

9	1 x	5325.200
10	2 x	5325.300

LED DRIVER

LED DRIVER

7

12	8 x 30	2 x	2842
13	5,8 x 55	2 x	2840

LED DRIVER



D

Wichtige Sicherheitshinweise

Die Installation Ihrer neuen Leuchte darf ausschließlich von autorisierten Fachpersonen durchgeführt werden.



www.till-hilft.de

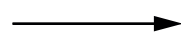

Montagehilfen



PL

Ważne wskazówki dotyczące bezpieczeństwa

Ta instalację nowej lampy mogą przeprowadzać wyłącznie autoryzowani instalatorzy



www.till-hilft.de

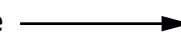

Montagehilfen



GB

Important safety instructions

The installation of your new luminaire may only be carried out by authorized specialists.



www.till-hilft.de

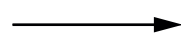

Montagehilfen



SK

Dôležité bezpečnostné upozornenia

Inštaláciu lampy smú vykonať výhradne autorizovaní



www.till-hilft.de

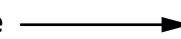

Montagehilfen



FR

signes de sécurité importantes

La L'installation votre nouveau luminaire doit uniquement être réalisée par des spécialistes autorisés



www.till-hilft.de

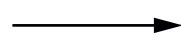

Montagehilfen



HU

Fontos biztonsági utmutatások

Az On Új lámpájának beszerelését kizárólag hivatalos szakember végezheti el



www.till-hilft.de

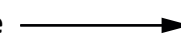

Montagehilfen



IT

Important disposizioni di sicurezza

L'installazione della il loro nuovo lampada può essere eseguita solo ed esclusivamente da personale tecnico autorizzato.



www.till-hilft.de

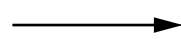

Montagehilfen



RO

Instrucțiuni de siguranță importante

Instalarea noii dumneavoastră lămpi este permisă exclusiv specialișilor autorizați



www.till-hilft.de

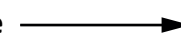

Montagehilfen



NL

Belangrijke veiligheidsaanwijzingen

De installatie van de nieuwe lamp moet worden uitgevoerd door vakbekwame personen worden uitgevoerd.



www.till-hilft.de



Montagehilfen



TR

Önemli güvenlik uyarıları

Yeni lamba montajı yetkin kişiler tarafından yapılmalıdır



www.till-hilft.de

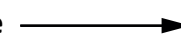

Montagehilfen



CZ

Důležité bezpečnostní pokyny

Instalaci nových svídel smí provádět pouze kvalifikovaný elektrikář



www.till-hilft.de



Montagehilfen



RU

важная информация по технике безопасности

Установка вашей новой лампы должна выполняться квалифицированным персоналом



www.till-hilft.de



Montagehilfen



89904.330



D

Wichtige Sicherheitshinweise

Die Installation Ihrer neuen Leuchte darf ausschließlich von autorisierten Fachpersonen durchgeführt werden.



www.till-hilft.de

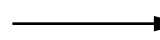

Montagehilfen



PL

Ważne wskazówki dotyczące bezpieczeństwa

Ta instalację nowej lampy mogą przeprowadzać wyłącznie autoryzowani instalatorzy



www.till-hilft.de

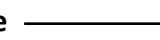

Montagehilfen



GB

Important safety instructions

The installation of your new luminaire may only be carried out by authorized specialists.



www.till-hilft.de

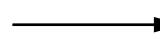

Montagehilfen



SK

Dôležité bezpečnostné upozornenia

Inštaláciu lampy smú vykonať výhradne autorizovani



www.till-hilft.de

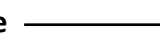

Montagehilfen



FR

signes de sécurité importantes

La L'installation votre nouveau luminaire doit uniquement être réalisée par des spécialistes autorisés



www.till-hilft.de

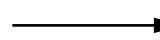

Montagehilfen



HU

Fontos biztonsági utmutatások

Az On Új lámpájának beszerelését kizárólag hivatalos szakember végezheti el



www.till-hilft.de

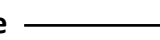

Montagehilfen



IT

Important disposizioni di sicurezza

L'installazione della il loro nuovo lampada può essere eseguita solo ed esclusivamente da personale tecnico autorizzato.



www.till-hilft.de

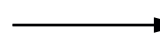

Montagehilfen



RO

Instrucțiuni de siguranță importante

Instalarea noii dumneavoastră lămpi este permisă exclusiv specialișilor autorizați



www.till-hilft.de

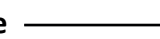

Montagehilfen



NL

Belangrijke veiligheidsaanwijzingen

De installatie van de nieuwe lamp moet worden uitgevoerd door vakbekwame personen worden uitgevoerd.



www.till-hilft.de

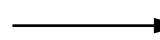

Montagehilfen



TR

Önemli güvenlik uyarıları

Yeni lamba montajı yetkin kişiler tarafından yapılmalıdır



www.till-hilft.de



Montagehilfen



CZ

Důležité bezpečnostní pokyny

Instalaci nových svídel smí provádět pouze kvalifikovaný elektrikář



www.till-hilft.de



Montagehilfen



RU

важная информация по технике безопасности

Установка вашей новой лампы должна выполняться квалифицированным персоналом



www.till-hilft.de



Montagehilfen



89904.330



1 4 x 2802	2 4 x 2801	3 2 x 1946	4 3 x 13,5 4 x 1123	5 8 x 30 14 x 2861
6 3 x 15 1 x 2803	7 1 x 5325	8 1 x 5325.100	9 1 x 5325.200	10 2 x 5325.300
11 Leim 1 x 2863	12 8 x 30 2 x 2842	13 5,8 x 55 2 x 2840		

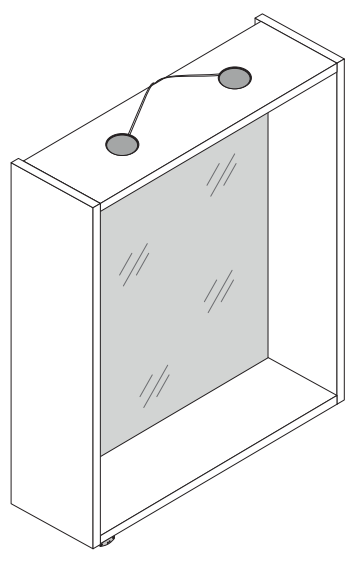
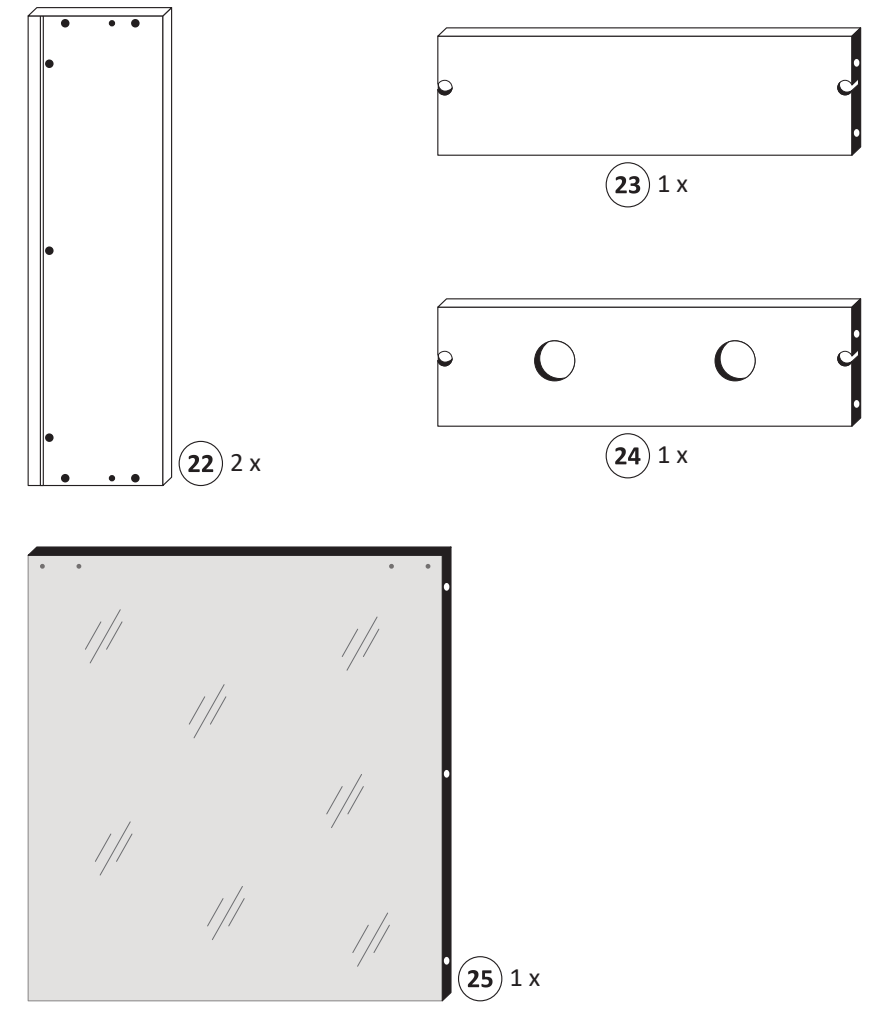
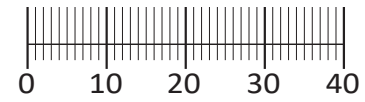

88701.331

Das beigefügte Wandbefestigungsmaterial (Dübel und Schrauben) eignet sich nur für festes Mauerwerk (z.B.: Beton- oder Ziegelwände). Für andere Wandaufbauten sind eventuell Spezialdübel und andere Schrauben notwendig. Ziehen Sie gegebenenfalls eine Fachkraft zu Rate.

De begeleidende wandmontage hardware (pluggen en schroeven) is alleen geschikt voor massief metselwerk (bijvoorbeeld beton of bakstenen muren). Voor andere muur structuren zijn eventueel bijzondere ankerbouten en andere noodzakelijke. Draai indien nodig, een deskundige.

Приложенный материал для крепления к стене (дюбели и винты) пригоден только для жестких кладок (например, бетонные или кирпичные стены). Для других настенных конструкций необходимы смотря по обстоятельствам специальные дюбели и другие винты. При необходимости проконсультируйтесь у специалиста.

Le mur d'accompagnement matériel de montage (chevilles et les vis) ne convient que pour la maçonnerie solide (par exemple en béton ou des murs de briques). Pour les structures de mur d'autres sont peut-être spéciale boulons d'ancrage et d'autres nécessaires. Serrer le cas échéant, un expert.

Załączony materiał do mocowania do ściany (kolki rozprężne i wkręty) nadaje się tylko do ścian murowanych (np. z betonu lub cegiel). Do ścian wykonanych w innych technologiach konieczne być mogą specjalne kolki rozprężne i inne wkręty. W razie potrzeby skorzystaj z fachowej pomocy

Il muro di accompagnamento hardware di montaggio (tasselli e viti) è adatto solo per muratura piena (ad esempio calcestruzzo o muratura). Per le altre strutture murarie sono forse speciali bulloni di ancoraggio e necessari di altri. Serrare se necessario, un esperto.

The accompanying wall mounting hardware (anchors and screws) is suitable only for solid masonry (eg concrete or brick walls). For other wall structures are possibly special anchor bolts and other necessary. Tighten if necessary, an expert.

Ekteki duvara sabit montaj malzemeleri (dübel ve vidalar), sadece sağlam duvarlar için (örnek: beton veya tuğla) elverişlidir. Başka duvarlar için özel dübeller ve farklı vidalar gerekebilir. Gerektiğinde bir uzmana danışınız.

1

4 x 2802

2

4 x 2801, 8 x 30 2861, Leim 2863

3

2 x 1946, 3 x 13,5 4 x 1123, 8 x 30 14 x 2861, Leim 2863

oben

