

# PAXOS SINGLE BED

Simple Assembly Instruction - Please keep for future reference



## COMPONENTS

01 1 X HEADBOARD

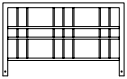

02 1 X FOOTBOARD

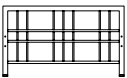

03 2 X SIDE RAIL



04 2 X SUPPORT RAILS



05 15 X SPRING SLAT



06 2 X SHORT POST

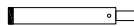





## IMPORTANT

- 1) Read these instruction carefully and familiarise your self with the procedure before assembling the unit.
- 2) Check that you have all the component parts following the list on the back cover and familiarise yourself with each part before proceeding.
- 3) Take all the fitting out of the plastic bag and separate them into their groups.
- 4) Ensure you have enough space to layout all the parts before assembly.
- 5) To avoid scratching it is recommended that you assemble the unit on a soft level surface.

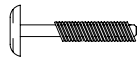

TWO PEOPLE ARE NEEDED TO ASSEMBLY THIS BUNK.



## FITTINGS

<p><b>A</b></p>  <p>SCREW M6 X 15MM</p> <p>8 PCS</p>	<p><b>B</b></p>  <p>SCREW M6 x 45MM</p> <p>4 PCS</p>	<p><b>C</b></p>  <p>JCN NUT M6 x 20MM</p> <p>4 PCS</p>	<p><b>D</b></p>  <p>SIDE SLAT STOPPER</p> <p>30 PCS</p>	<p><b>E</b></p>  <p>M4 ALLEN KEY</p> <p>2 PCS</p>
---------------------------------------------------------------------------------------------------------------------------------------------	---------------------------------------------------------------------------------------------------------------------------------------------	-----------------------------------------------------------------------------------------------------------------------------------------------	---------------------------------------------------------------------------------------------------------------------------------------------	----------------------------------------------------------------------------------------------------------------------------------------

WE STRONGLY RECOMMEND THAT YOU **DO NOT** USE POWER TOOLS DURING ASSEMBLY. POWER TOOLS CAN OVERTIGHTEN AND **DAMAGE COMPONENTS** OR MAKE THE **PRODUCT UNSAFE**. AND DAMAGE DUE TO THE USE OF POWER TOOLS ARE AT THE CUSTOMERS OWN RISK AND WILL NOT BE ACCEPTED BACK BY THE SUPPLIER. WE RECOMMEND YOU USE THE TOOLS PROVIDED IN YOUR ASSEMBLY KIT.

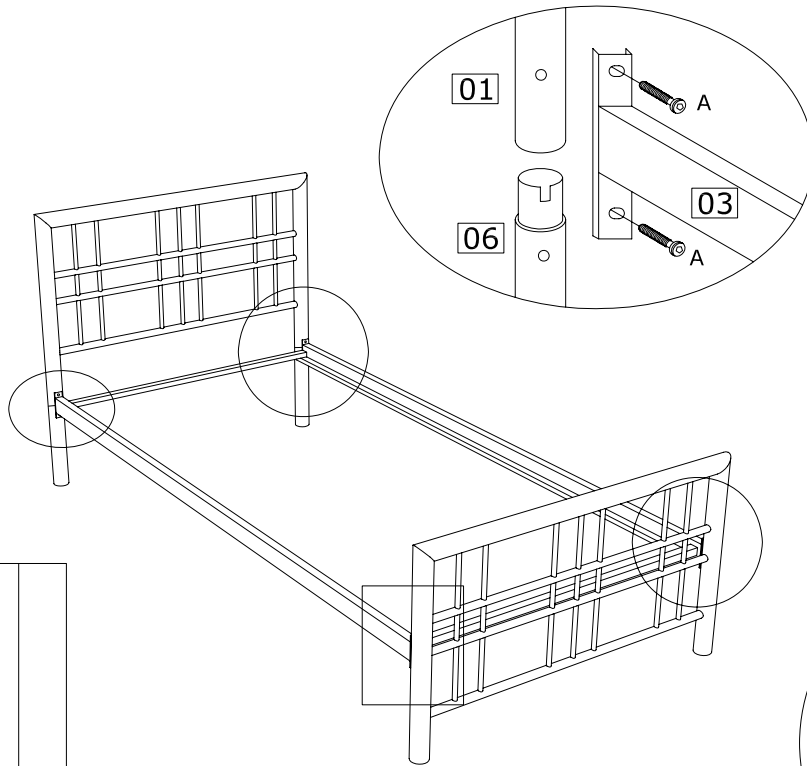
# Step 1

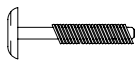

A		8 PCS
SCREW M6 X 15MM		
B		4 PCS
SCREW M6 x 45MM		
C		4 PCS
JCN NUT M6 x 20MM		

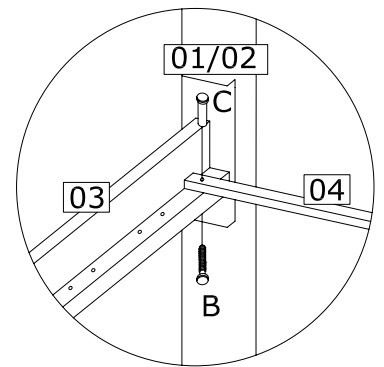
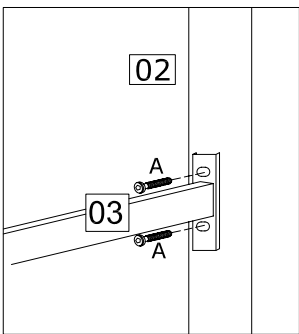

# Step 2

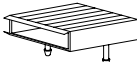

D		30 PCS
SIDE SLAT STOPPER		

